



austyle architectural hardware



# auSTYLE architectural hardware

The austyle philosophy demonstrates how good ideas become reality.

Every austyle product is designed and manufactured with an emphasis on quality raw materials, practical functionality and unique designs.

Whether the product is 304, 316 stainless steel or solid virgin brass, strength in foundation through the use of high grade raw materials ensures austyle products can withstand the tolerances required in all commercial or domestic, internal or external applications.

auSTYLE Architectural Hardware and Builders Choice Hardware are brands of Superior Brass. Established in 1982 and starting with a traditional range of 10 lever handles, the range now extends to over 3000 products across multiple brands and multiple market segments.

Austyle products are manufactured to exceed ISO9000 international quality standards and are mechanically and practically functional as well as simple and easy to install.

Our in house design team develops products that reflect current market styles and trends and many of our unique designs have design registrations and mechanical patents to protect their individuality.

Welcome to the austyle range of quality architectural hardware and a new approach in design innovation.

## opening doors in auSTYLE

Head Office / Showroom  
137-145 Chesterville Rd.  
Moorabbin, Victoria 3189, Australia

Postal  
P.O.Box 623 Moorabbin,  
Victoria 3189, Australia

### myLOCK

## Practical & Multi-Functional Living.

### Integrated Latch, Privacy & Dead Bolt

Now available in both 30mm and 60mm backsets



PROJECT SERIES  
[builderschoicehardware.com.au](http://builderschoicehardware.com.au)



MODERN COMMERCIAL  
[austyle.com.au](http://austyle.com.au)



TRADITIONAL & CLASSIC  
[superiorbrass.com.au](http://superiorbrass.com.au)

# Contents - Selecting the Right Hardware

<b>Door Handles</b>	<b>18</b>	Escutcheon Covers	74
316 Stainless Steel Passage/Privacy sets	20-21	Bathroom Locking Options Sliding & Hinges Doors	75-76
DDA Compliant Commercial Lever Sets	23		
Long Plate Entrance Sets 228mm 316 Stainless Steel - Fire Rated	24-29	<b>Flush Pull Handles</b>	<b>78</b>
Long Plate Entrance Sets 225mm Builders Choice Range	30-31	Sliding Door Flush Pulls	80
Long Plate Entrance Sets 200mm	32	Integrated Entrance Door Flush Pull	81
Project Series Key-in-lever sets	34	Sliding Door Edge Pulls	81
<b>Feature Entry Pull Handles</b>	<b>36</b>	<b>Kitchen/Cupboard Handles</b>	<b>82</b>
Timber Options	38-39	Drawer Pull Handles	84-85
Designer Series	40-43	Knobs Pulls	86-87
Integrated Flush/Pull Handle	44	<b>Hinges</b>	<b>88</b>
Aluminium Series	45	Commercial Fire Rated Butt Hinges	90
Glass	46	Square Knuckle Butt Hinges	90
Round	51	Broad Butt Hinges	91
Offsets	58	Ball Bearing Hinges	91
Square	61	Fast Fix Hipline Ball Bearing Hinges	92
Accessories	61	Long Body Heavy Duty Hinges	92
<b>Security</b>	<b>62</b>	Radius Hinges	92
Residential myLOCK Integrated Keyless Snibbing Latch & Roller	64-65	Bathroom Door - Lift Off Hinges	93
Residential Quad Lock – Multi Function Entrance Lock	66	Bathroom Door - Self Closing Hinges	93
Narrow Back-set Locks (Aluminium)	69	<b>Door Bolts</b>	<b>94</b>
Roller Locks	70	Panic Bolts (Including Keepers & Accessories)	95
Self-Latching Security	70	Barrel Bolts	97
Cavity/Sliding Door Locks	71	Flush Bolts	97
Dead Bolt	71	<b>Door Stops</b>	<b>98</b>
Security Cylinders	72	Wall / Floor Mount	100
Bathroom Privacy Adaptors	72	Heavy Duty Door Catches	101
Passage Latches	73	Magnetic Door Catches	101
Roller & Ball Catches	73	<b>Alphabet &amp; Numerals</b>	<b>102</b>
Magnetic Door Catch	73	House Numerals	104
		Alphabet	105
		Bathroom Signs	105

## Family Ranging

Satin Brass Finish	8-9
Matt Black Finish	10-11
Satin Stainless Steel Finish	12-13
White & Monument Finishes	14-15
Security Family - Timber Doors	16
Security Family - Aluminium Doors	17



Door Handles / Passage, Privacy & Entrance Sets **P.18**



Feature Entrance Handles **P.36**



Security **P.62**



Flush Pull Handles **P.78**



Joinery Kitchen Cupboard Handles **P.82**



Hinges **P.88**



Flush, Panic, Door / Window Bolts **P.94**



Door Stops and Catches **P.98**



Numbers and Alphabet **P.102**

# Product Numbers

## PREFIX = FINISH

The prefix digit represent the finish color - see below

0-9

## BASE PRODUCT NUMBER

The LAST four digits represent the base item number.

XXXX

# Finishes

<b>PB</b>	[none]	Polished Brass [4 digit product number]
<b>PVD</b>	1	PVD Brass Finish - 50 year Anti-Tarnish Warranty
<b>ATQ</b>	2	Antique Finish with Copper Highlight
<b>CP/ PSS</b>	3	Chrome Plate or Polished Stainless Steel Finish
<b>SC/ SSS</b>	4	Satin Chrome or Satin Stainless Steel Finish
<b>MB</b>	5	Matt Black
<b>COP</b>	6	Polished Copper Finish
<b>ATQ BNZ</b>	7	Antique Bronze
<b>WH</b>	8WH	White
<b>MO</b>	8MO	Monument
<b>SB</b>	9	Satin Brass
●		Plated To Order

# Key Hole Punching Legend



## myLOCK

**DETERMINING THE HANDING**  
Standing on the INSIDE and facing the door... Which way is the lever pointing?



**EURO CYLINDER**  
85mm C/C  
XXXXE

**EURO CYLINDER**  
47.6mm C/C  
XXXXA

**PRIVACY**  
57mm C/C  
XXXXP

**SKELETON KEY**  
57mm C/C  
XXXXK

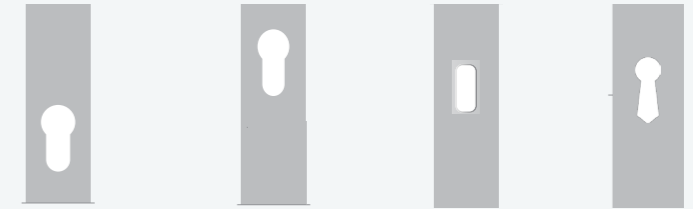

# Icon References



The Ball Bearing is the invisible hero of a friction free operation. The Stainless Steel ball bearing promotes smooth mechanical operation, durability and longevity. The Ball Bearing accompanies a four hour fire rating (Australian Standard # AS1530.4-1997 and BS476.). There are no assembled plastics or nylons in the austyle lever mechanisms.



Quality is never an accident, it is the result of intention, innovation and skillful execution. When the base materials used in manufacturing are of a high standard, the end product lends itself to comprehensive long term mechanical confidence. Our products will simply work and accompany a 7 year residential warranty.



Many items in our range are manufactured using 304 or 316 stainless steel where commonly these types of products are usually manufactured by our competitors in zinc or steel. Stainless Steel offers significantly superior durability and reliability whether used as the base material of the product structure or within its mechanism.



The PVD Brass Finish offers a traditional appearance with a 50 Year Anti-Tarnish warranty against, pitting, discolouring and corrosion. If your project/client has a traditional brief/style with all the benefits of modern durable mechanical operation, this is the product for you. ([www.superiorbrass.com](http://www.superiorbrass.com))



Many austyle locks have been fire tested in Australia and have passed either 2 and 4 hours in simulated fire conditions. The rating refers to the fire test only. Installers and specifiers should verify and ensure the appropriate lock meets the appropriate operational building code or fire door requirement.



The austyle ball bearing mechanism, myLOCK and Quadlocks are patented which protects its exclusivity, individuality and uniqueness. Choosing an austyle patented product ensures you're purchasing a product designed in Australia for the Australian market.



All austyle lever handles and heavy duty passage latches have accompanying long term mechanical warranties. After correct installation, you can relax with long term confidence that our product will simply continue to operate as it did on day one.



Austyle passage sets have a unique tamper proof mechanism. When installed correctly, the external lever will not have a visible screw head under the concealing ring. This prevents the handle being tampered with and removed from the external side to gain internal access.

# Satin Brass Finish

SB



**93580 Square Lever Set.**  
SS Ball Bearing Mechanism.  
ALL IN ONE - Passage & Privacy options included.  
63mm backplates -Ideal for retro fitting into existing doors.

93733 **Escutcheon** Cover 52mm  
99209 **Entrance Lock** 60mm/85mm  
99144 **Double Cylinder** 65mm (SB)



**93585 Linear Lever Set**  
All In One - Passage and Privacy (pictured)



**93589 Tubular Lever Set**  
SS Ball Bearing Mechanism  
ALL IN ONE - Passage & Privacy options included  
63mm backplates -Ideal for retro fitting into existing doors



**Blade Entry Pull Handle**

93936  
Blade Pull Handle  
450mm (40x15mm)

93724  
Concealed  
Rectangle  
Escutcheon  
70x30mm

Cylinder  
95144



**Square Entry Pull Handle**

93995  
450mm (20x40mm)

93996  
600mm (20x40mm)

93736  
Escutcheon Snib Set  
145x40mm

19217  
myLOCK  
Entrance Roller  
Lock

**Circular Pull Handle**  
Concealed Fix  
Includes 80mm Fixing Bolts  
300mm Diam

53994 **MB**  
93994 **SB**

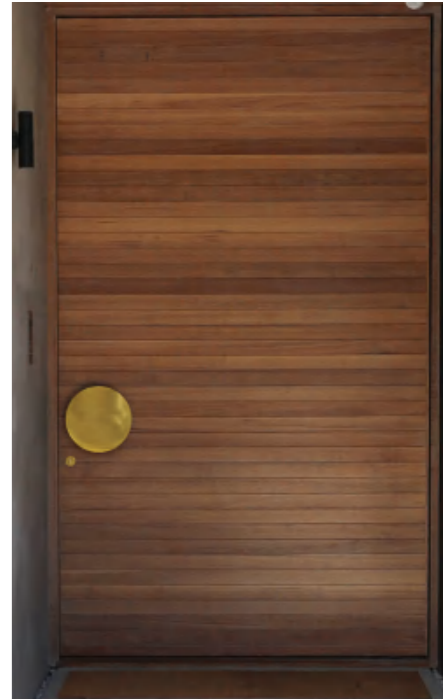

**Cavity Sliding Door**  
Passage 93757  
Privacy 93758  
Entrance 93789

**Sliding Door Flush Pull**  
93749  
Flush Pull 150x50mm.

**Sliding Door Edge Pull**  
94455 - 80x25mm.

**Hinges**  
95108  
100x75x2.5mm  
Fixed Pin

95109  
100x100x2.5mm  
Fixed Pin



**Fast Fix Hinges**  
95245SB  
100x47x2.5mm

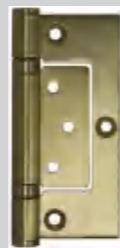

**Door Stop**

93080 Floor Mounted Round Stop 45mm

93717 Wall Mounted Tube Stop 75mm



**Cabinet Pull Handle**  
98702 12 x 12mm x 236mm



**Bathroom Doors**

99040  
Recessed bathroom  
privacy snibs 40mm diam  
(use with 19033 latch)

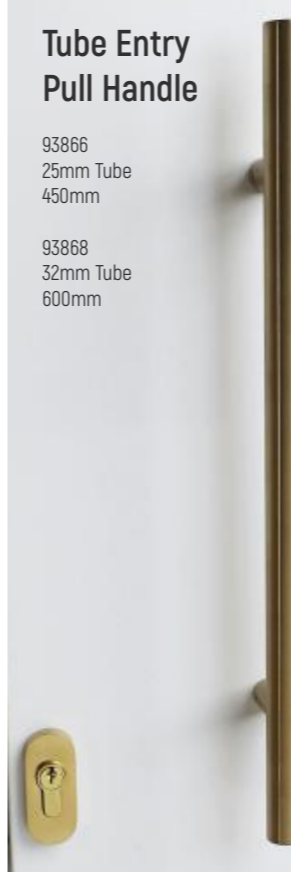
**Tube Entry Pull Handle**

93866  
25mm Tube  
450mm

93868  
32mm Tube  
600mm



**Tapered Offset Entry Pull Handle**

93928  
450mm Tapered  
Offset Pull

93929  
600mm Tapered  
Offset Pull

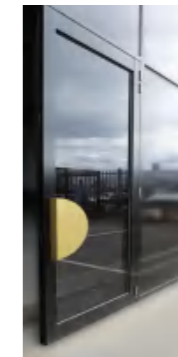

**Half Circle Entry Pull Handle**  
Concealed Fix  
Includes 80mm Fixing Bolts

**300mm diam. 500mm diam. (Pictured)**

53993 53992 **MB**  
93993 93992 **SB**



**"C" Semi Circle Entry Pull Handle**  
Concealed Fix  
Includes 80mm Fixing Bolts  
300mm diam.

53991 **MB**  
93991 **SB**



# Matt Black Finish

**MB**

## Entrance Family



## Internal Family

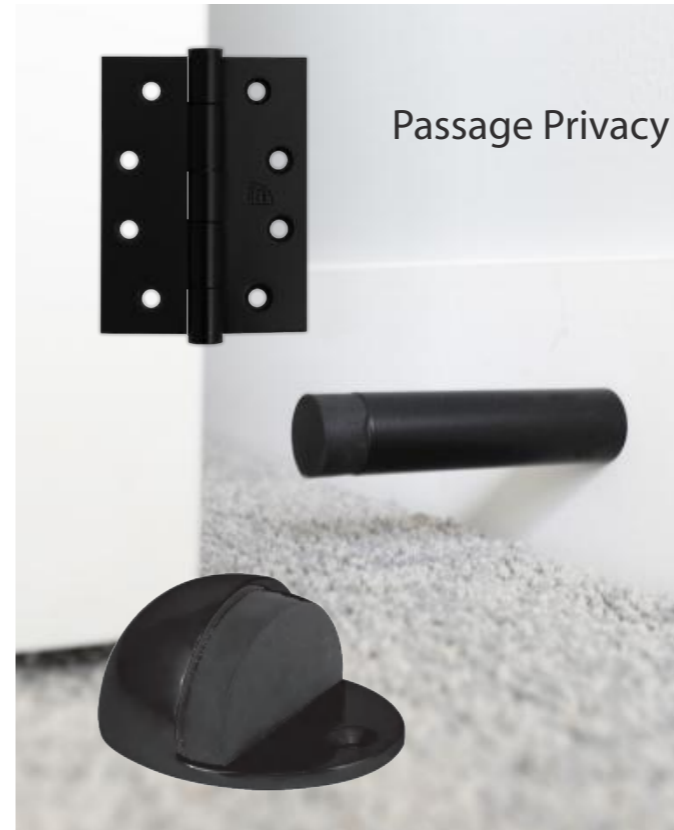

## Front Doors Roller Entrance Locks / Pull Handles



## Sliding Doors Flush Pull / Edge Pull Cavity Door Privacy Lock



# Satin Stainless Steel Finish

SSS



## Entrance Family

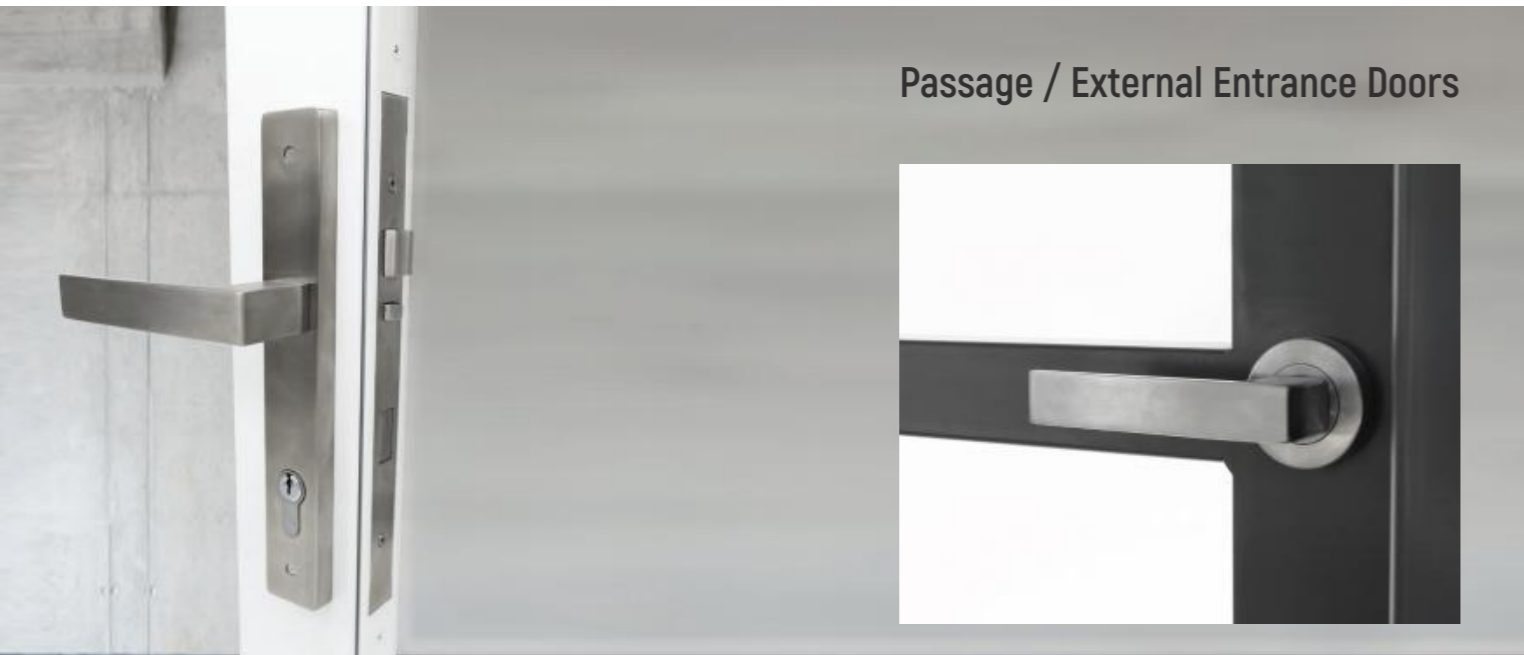

## Internal Family

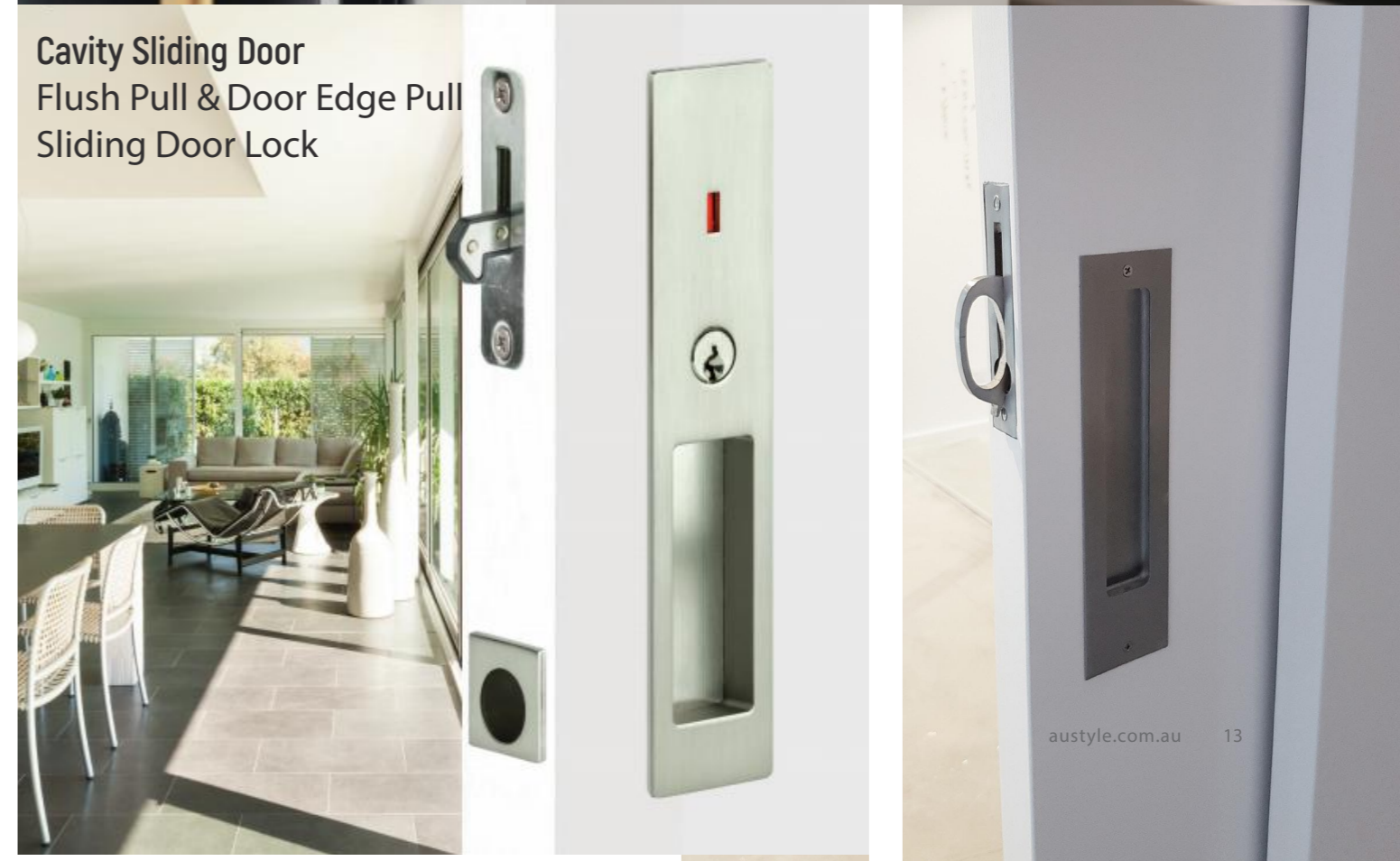
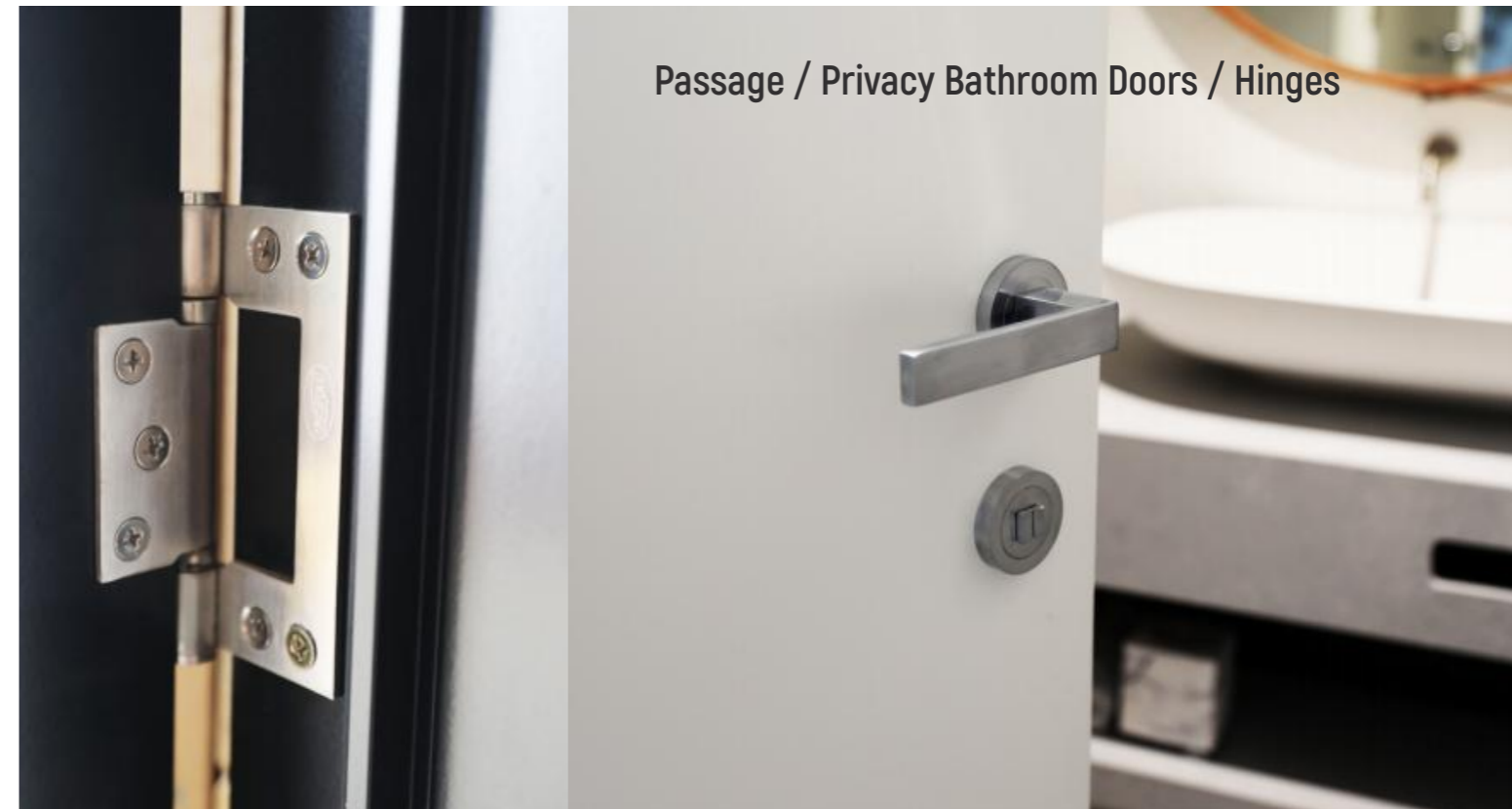

# White Family

WH



83580 (63mm Rose)  
Lever Handle



83585 (63mm Rose)  
Lever Handle

83936WH  
Blade Pull  
Handle  
450mm

83995-450mm  
83996-600mm



83830  
Offset Entry  
Pull Handle  
600mm

83724  
Rectangle  
Escutcheon

89144  
65mm Cylinder



85118 Loose Pin  
Fire Rated Hinge  
100x75x2.5mm



83749  
Flush Pull  
150x50mm



83868WH  
Entry Pull  
Handle  
600mm

83736  
myLOCK  
Escutcheon  
Snib

89144  
65mm Cylinder



# Monument Family

MO

Plated To Order



83580MO (63mm Rose)  
Lever Handle

83888MO Pull Entry Handle 500mm  
83724MO Rectangle Escutcheon  
89144MO Double Cylinder 65mm

83936MO  
Blade Pull Handle  
450mm

85108MO  
Hinge  
100x75mm





# Security Family - Timber doors

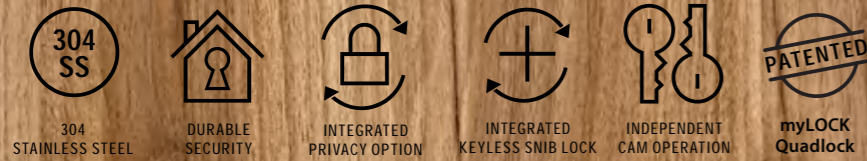

## myLOCK Entrance Roller

### myLOCK

Integrated Roller  
Privacy & Dead bolt functionality  
Front Adjustable Roller Tension  
60mm Backset / 83mm Overall

19217 **PVD**  
29217 **ATO** See Page 64/65  
39217 **PSS** for all Features  
49217 **SSS** & benefits  
59217 **MB**  
69217 **COP**

Rebate Kit Available x9220



## myLOCK Entrance

### myLOCK

Integrated Roller  
Privacy & Dead bolt functionality  
85mm C/C / 36mm Privacy C/C  
60mm Backset / 83mm Overall

19219 **PVD**  
29219 **ATO** See Page 64/65  
39219 **PSS** for all Features  
49219 **SSS** & benefits  
59219 **MB**

Rebate Kit Available x9220



## Dead Latch Escape

Emergency Escape Function  
Dead Latching Trigger  
Ideal for All Fire Doors  
60mm Backset / 83mm Overall

49301 **SSS**  
59301 **MB**



## Multi-Function Entrance Lock

### QuadLock

4 Modes Of Operation  
Emergency Escape Option  
Dead Latching Mode Option  
Dead Bolt Mode Option  
Latching Mode Option

Ideal for All Escape / Fire Doors  
60mm Backset / 83mm Overall

19300 **PVD**  
29300 **ATO** See Page 66/67  
39300 **PSS** for all Features  
49300 **SSS** & benefits  
59300 **MB**

Rebate Kit Available x9304



## Entrance Sliding Door

Elongated Striker Plate Holes  
Allows For Movement Of The Door  
2 Locating Pins Guide The Door  
Into correct Position When  
Closing  
45mm Backset / 62mm Overall

9086 **PVD** 49086 **SSS**  
29086 **ATO** 59086 **MB**  
39086 **PSS**

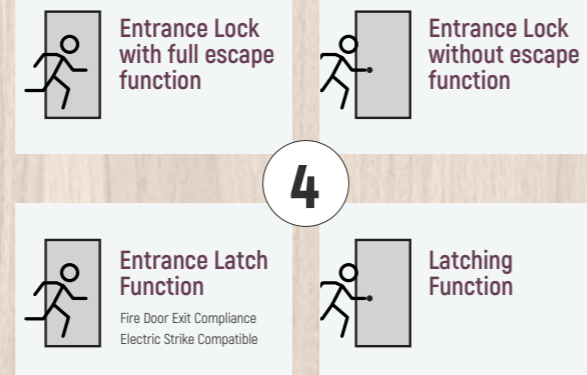

4

# QuadLock

# Security Family - Aluminium doors

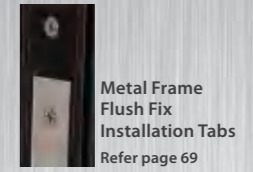

## myLOCK Entrance Roller

### myLOCK

Integrated Roller  
Privacy & Dead bolt functionality  
Front Adjustable Roller Tension  
30mm Backset / 47mm Overall

49214 **SSS** See Page 64/65  
59214 **MB** for all Features  
& benefits

Rebate Kit Available x9220



## Multi-Function Entrance Lock

### QuadLock

Multi Function entrance Lock  
4 Modes Of Operation  
30mm Backset / 47mm Overall

49311 **SSS** See Page 66/67  
59311 **MB** for all Features  
& benefits

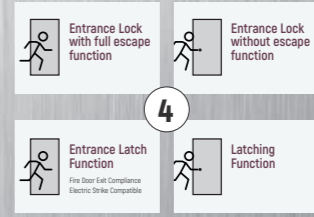

4

## myLOCK Entrance Sliding

### myLOCK

Integrated Sliding Door  
Privacy & Dead bolt functionality  
30mm Backset / 47mm Overall

49285 **SSS** See Page 64/65  
59285 **MB** for all Features  
& benefits



## Entrance Roller Lock

Roller Latching Function  
Front Adjustable Roller Tension  
30mm Backset / 47mm Overall

49204 **SSS**  
59204 **MB**

Rebate Kit Available x9220



## myLOCK Entrance

### myLOCK

Integrated Roller  
Privacy & Dead bolt functionality  
85mm C/C / 36mm Privacy C/C  
30mm Backset / 47mm Overall

19211 **PVD**  
39211 **PSS** See Page 64/65  
49211 **SSS** for all Features  
59211 **MB** & benefits

Rebate Kit Available x9220



## Entrance Lever Lock

Lever Latching Function with  
retractable latch by cylinder  
85mm C/C  
30mm Backset / 47mm Overall

49201 **SSS**  
59201 **MB**

25mm Backset  
49200 **SSS**

Rebate Kit Available x9210



## Door Handles, Passage, Privacy & Entrance Sets



MECHANICAL  
WARRANTY



316  
STAINLESS STEEL

# Lever Handles



MECHANICAL WARRANTY



FIRE RATING



316 STAINLESS STEEL



304 SS BALL BEARING RACE MECHANISM



PATENTED MECHANISM



DDA COMPLIANT 42300

To Order **MB**

Material:  
P.20 - 316 Stainless Steel  
P.21 - Forged Solid Brass

Reference:  
All In One Includes Integrated Privacy Option

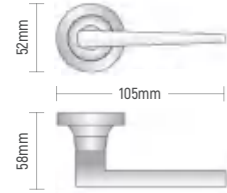

42309

SSS



42310

SSS



42320

SSS



42304

SSS



42329 - Passage  
42329P - Privacy

## Square Adaptor Plates

Use the square adaptor plate to convert the round back plate to a square design on any lever of your choice.



42318

SSS



42325

SSS



42314

SSS



42300



DDA COMPLIANT

SSS



PVD CP SC ORDER MB  
13510 33510 43510 53510



PVD CP SC ORDER MB  
13511 33511 43511 53511



PVD CP SC ORDER MB  
13516 33516 43516 53516



PVD CP SC ORDER MB  
13520 33520 43520 53520



CP SC ORDER MB  
33512 43512 53512



33539 CP  
43659 SC  
53539 ORDER MB

## Square Adaptor Plates



PVD CP SC ORDER MB COP  
13518 33518 43518 53518 63518



PVD CP 316 SSS ORDER MB  
13514 33514 42314 52314



PVD CP 316 SSS ORDER MB  
12309 33509 42309 52309  
All In On - Passage/Privacy



PVD  
13519



# Accessories



Passage Door Latch

60mm Back Set **PB** **ATO** **CP** **SC** **MB** **COP**  
 9031 29031 39031 49031 59031 69031  
 45mm Back Set 9028 29028 39028 49028 59028



49024 <sup>SC</sup>  
 Magnetic Passage Door Latch  
 50mm backset



9822  
 Dummy Fixing Spindle  
 for single side fixing installation



9821  
 Spare Spindle Screws Kit  
 2 x Sprung spindles  
 2 x Tie Bolt Fixing screws  
 1 set with concealed head

## Backing Cover Plates

Sit behind back plate and covers pre drilled holes in the door (63mm)



Round Plate **PVD** **CP** **SC** **MB**  
 19816 39816 49816 59816  
 Square Plate **SC** **MB**  
 49818 59818

## Adaptor Cover Plates

Multipurpose "Slip Over" auSTYLE passage sets to cover pre-existing holes in the door.



M myLock p.65  
 A 47.6mm euro cyl hole p.68  
 E 85mm euro cyl hole p.68  
 L Oval cyl  
**SC** **MB**  
 43566 53566

## THE AUSTYLE DIFFERENCE IS AS SIMPLE AS 1-2-3

1

The Ball Bearing mechanism is the invisible hero of a friction free operation.

2

The Stainless Steel ball bearing mechanism promotes smooth mechanical operation, durability and longevity.

3

The Ball Bearing mechanism accompanies a four hour fire rating (Australian Standard # AS1530.4-1997 and BS476.)

Contact one of our distributors to touch and feel the auSTYLE lever handle difference in store.



# DDA Compliant Lever Handles



## DDA Compliant

For buildings used for the provision of a service or employment, the Disability Discrimination Act 2005 (DDA) gives disabled people important rights of access to everyday services.  
 Concealed screw head for tamper proof, high security fixing.



**SC**  
 42330 Passage Set  
 42330E Entrance Set



**MB**  
 52330 Passage Set  
 52330E Entrance Set



**SC**  
 43665 Passage Set  
 43665E Entrance Set Set



**MB**  
 53665 Passage Set  
 53665E Entrance Set Set



**316 SSS**  
 42300 Lever Passage Set



**MB**  
 53560 Lever Passage Set



**SC**  
 43555 Lever Passage Set



**MB**  
 53555 Lever Passage Set



42300+42329 Lever Passage Set with Square Plate **316 SSS**



53560+53539 Lever Passage Set with Square Plate **MB**



43555+43539 Lever Passage Set with Square Plate **SC**



53555+53539 Lever Passage Set with Square Plate **MB**

# Entrance and Passage

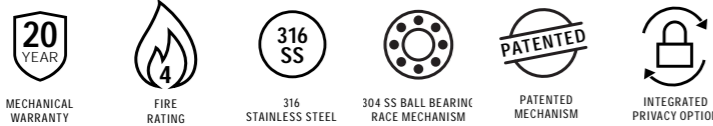

To Order  
**MB**

Material:  
316 Marine Grade Stainless Steel

Long Plates:  
228x32mm  
58mm Projection  
Concealed Screw Head For  
Tamper Proof Fixing

Passage Sets  
52mm Diam/Square

Options:  
Passage  
Entrance  
Inverted Lever  
myLOCK ®

Reference:  
E Entrance  
85mm Locks  
L Reversed Lever  
M myLOCK ®  
Specify LH/RH  
P Privacy  
Bathroom Lock

## ENTRANCE & PASSAGE EXPLAINED

**E** - Entrance Sets can be used with all high security entrance locks @ 85mm centres. Refer security section.

**L** - Reversed lever set up.

**M** ® - Entrance Set can be used conjunction with myLOCK high security entrance locks. Refer security section. For myLOCK entrance sets - please specify LH/RH handing. HANDING > the INTERNAL side (where the snib sits) needs to be specified and denoted as "LH or RH".

### myLOCK

#### DETERMINING THE HANDING

Standing on the INSIDE and facing the door... Which way is the lever pointing?



EURO CYLINDER  
85mm C/C  
XXXX**E**



PRIVACY  
57mm C/C  
XXXX**P**

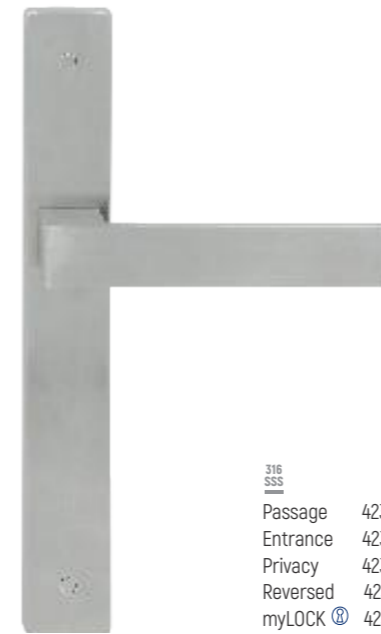
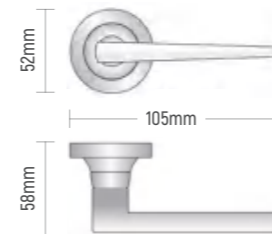
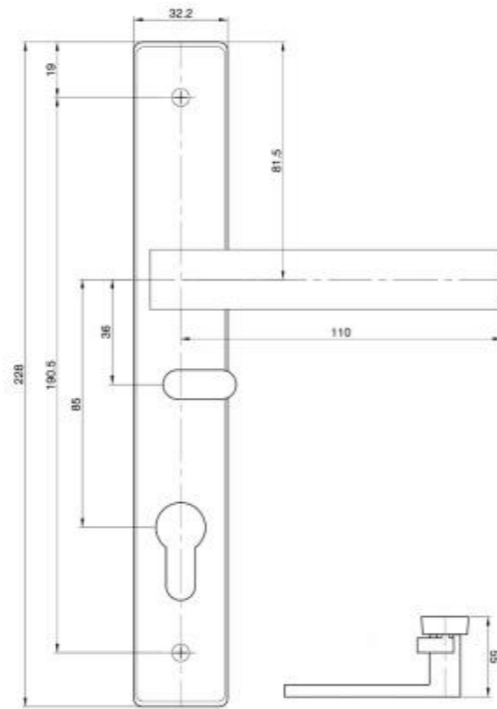

316  
SSS  
Passage 42340  
Entrance 42340E  
Privacy 42340P  
Reversed 42340L  
myLOCK ® 42340M



316  
SSS  
Passage 42355  
Entrance 42355E  
Privacy 42355P  
Reversed 42355L  
myLOCK ® 42355M



42310  
Lever Passage Set / Privacy Option

316  
SSS



42325  
Lever Passage Set / Privacy Option

316  
SSS

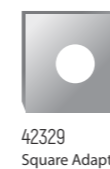

42329  
Square Adaptor Plate

Passage Set:  
42310 + 42329

Privacy Set:  
42310 + 42329P

316  
SSS

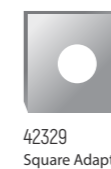

42329  
Square Adaptor Plate

Passage Set:  
42325 + 42329

Privacy Set:  
42325 + 42329P

316  
SSS

BASE PRODUCT NUMBER + PUNCHING LETTER = CORRECT ITEM #

# Entrance and Passage

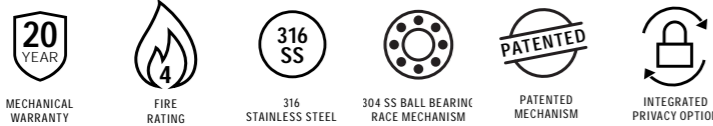

To Order

**MB**

Material:

316 Marine Grade Stainless Steel

Long Plates:

228x32mm  
58mm Projection  
Concealed Screw Head For  
Tamper Proof Fixing

Passage Sets:

52mm Diam/Square

Options:

Passage  
Entrance  
Inverted Lever  
myLOCK ®

Reference:

E Entrance  
85mm Locks  
L Reversed Lever  
M myLOCK ®  
Specify LH/RH  
P Privacy  
Bathroom Lock

**myLOCK**

## DETERMINING THE HANDING

Standing on the INSIDE and facing the door... Which way is the lever pointing?



EURO CYLINDER  
85mm C/C

xxxxE



PRIVACY  
57mm C/C

xxxxP

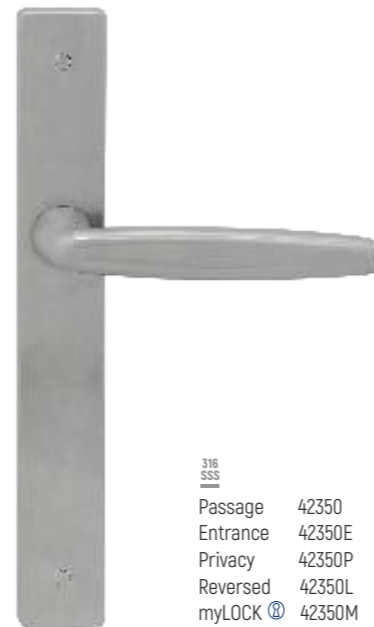

316 SSS  
Passage 42350  
Entrance 42350E  
Privacy 42350P  
Reversed 42350L  
myLOCK ® 42350M



316 SSS  
Passage 42344  
Entrance 42344E  
Privacy 42344P  
Reversed 42344L  
myLOCK ® 42344M



316 SSS  
Passage 42348  
Entrance 42348E  
Privacy 42348P  
Reversed 42348L  
myLOCK ® 42348M



42320  
Lever Passage Set / Privacy Option  
316 SSS



42329  
Square Adaptor Plate  
316 SSS

Passage Set: 42320 + 42329  
Privacy Set: 42320 + 42329P



42314  
Lever Passage Set / Privacy Option  
316 SSS



42329  
Square Adaptor Plate  
316 SSS

Passage Set: 42314 + 42329  
Privacy Set: 42314 + 42329P



43658  
Lever Passage Set / Privacy Option  
316 SSS



43659  
Square Adaptor Plate  
316 SSS

Passage Set: 43658 + 43659  
Privacy Set: 43658 + 43659P

Forged Brass Shorter 200mm Plate  
200x32mm 55mm Projection

	SC	ORDER MB
Passage	43618	53618
Entrance	43618E	53618E
Privacy	43618P	53618P
Skeleton Key	43618K	53618K
myLOCK ®	43618M	53618M



# Entrance and Passage

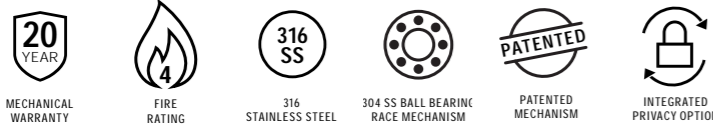

To Order  
**MB**

Material:  
316 Marine Grade Stainless Steel

Long Plates:  
228x32.2mm  
58mm Projection  
Concealed Screw Head For  
Tamper Proof Fixing

Passage Sets:  
52mm Round/Square

- Options::
- E Entrance  
85mm Locks
  - L Reversed Lever
  - M myLOCK Specify LH/RH
  - P Privacy  
Bathroom Lock

## myLOCK

### DETERMINING THE HANDING

Standing on the INSIDE and facing the door... Which way is the lever pointing?



EURO CYLINDER  
85mm C/C

xxxxE



PRIVACY  
57mm C/C

xxxxP



316 SSS  
Passage 42334  
Entrance 42334E  
Privacy 42334P  
Reversed 42334L  
myLOCK 42334M



316 SSS   
Passage 42330  
Entrance 42330E  
Privacy 42330P  
Reversed 42330L  
myLOCK 42330M



42304  
Lever Passage Set / Privacy Option

42329 Square Adaptor Plate

Passage Set: 42304 + 42329  
Privacy Set: 42304 + 42329P



42300   
Lever Passage Set / Privacy Option

42329 Square Adaptor Plate

Passage Set: 42300 + 42329  
Privacy Set: 42300 + 42329P



## DDA Compliant

42330 & 42300

For buildings used for the provision of a service or employment, the Disability Discrimination Act 2005 (DDA) gives disabled people important rights of access to everyday services.

## Passage Door Latch



SSS  
T Striker: 60mm Latch 49017 / 45mm Backset 49028  
D Striker: 60mm Latch 49031

All 52mm ROUND lever sets already come with a multi-function "T" striker latch which can be used for either passage or privacy door applications. (including all components).



## Escutcheon Cylinder Covers

Concealed Fixing. Sold cast 316SS. 52mm diameter.

316 SSS 43704 (refer P72 & 74 for cylinder and escutcheon cover options sold separately)



## Integrated Privacy Kits



SSS  
49016 - Privacy Latch Only (ea)  
49016P - Privacy Round Covers Only (pair)



SSS  
49016 - Privacy Latch Only (ea)  
49072P - Privacy Square Covers Only (pair)

All 52mm ROUND lever sets already come with a multi-function latch which can be used for either passage or privacy door applications. (including all components).



# Entrance and Passage Sets



www.builderschoicehardware.com.au

Material:  
Zinc

Long Plates:  
225x32mm  
55mm Projection  
Concealed Screw Head For  
Tamper Proof Fixing

Passage Sets:  
52mm Round  
52x52mm Square

Options:  
Passage  
Entrance  
myLOCK®  
Privacy/Bathroom  
Skeleton Key



Available in 316 Marine Grade  
Satin Stainless Steel P25



EURO CYLINDER  
85mm C/C



EURO CYLINDER  
47.6mm C/C



SKELETON KEY  
57mm C/C



PRIVACY  
57mm C/C



**All In One:**  
Includes both passage and privacy options all in the one box



**SC**  
43540



**MB**  
53540

**All In One:**  
Includes both passage and privacy options all in the one box



**SC**  
43545



**MB**  
53545

**All In One:**  
Includes both passage and privacy options all in the one box



**SC**  
43541

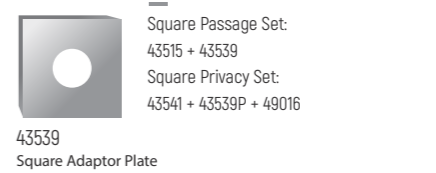

43539  
Square Adaptor Plate

**SC**  
Square Passage Set:  
43515 + 43539  
Square Privacy Set:  
43541 + 43539P + 49016

myLOCK

DETERMINING THE HANDING

Standing on the INSIDE and facing the door... Which way is the lever pointing?

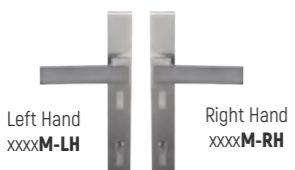

**SC**  
43570



**MB**  
53570

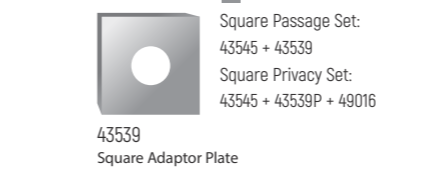

43539  
Square Adaptor Plate



**MB**  
53575



Visit [www.builderschoicehardware.com.au](http://www.builderschoicehardware.com.au)  
to see the full range of levers available.

Quality. Value. Style.



# Minimal Lever Range

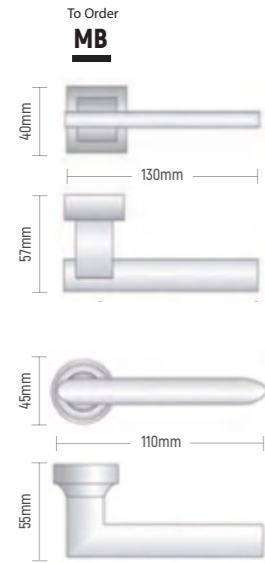

\*Indicative specifications



SC 43578 Passage Set



SC 43600 Passage Set  
CP 33600 Passage Set



SC 43576 Passage Set



SC 43603 Passage Set



SC 43577 Passage Set



SC 43605 Passage Set  
CP 33605 Passage Set

## PROJECT SERIES RANGE

Ideal for all residential projects

Adjustable 60/70mm backset latch

C4 Cylinder profile to Australian standards

64x64mm Backplates

55mm Projection



43561E Entrance Lock Set SC



43561P Bathroom Privacy Set SC



43561 Passage Set SC



43562 Single Dummy (fixed) SC



49252 Dead Bolt Double Cylinder Entrance SC



49253 Dead Bolt Single Cylinder/Turn Snib SC



49250 Dead Bolt Double Cylinder Entrance SC

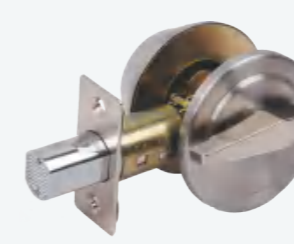

49251 Dead Bolt Single Cylinder/Turn Snib SC



Visit [www.builderschoicehardware.com.au](http://www.builderschoicehardware.com.au) to see the full range of levers available.

Quality. Value. Style.

Looking for a classical traditionally reproduced handle without compromising on security?



[www.traditionalhardware.com.au](http://www.traditionalhardware.com.au)



## Feature Entrance Handles

# Timber Entrance Handles



3950  
Pair back-to-back  
Timber Grain / Satin SS legs

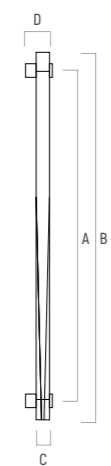

- A 1000mm
- B 1100mm
- C 43mm
- D 116mm

Fixing Screws: M8  
Fitting Holes: 10mm diameter

43862  
Pair back-to-back  
Solid Oak

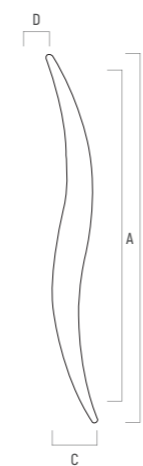

- A 400mm
- B 800mm
- C 60mm
- D 81mm

Fixing Screws: M8  
Fitting Holes: 10mm diameter

3946 - 600mm | 3948 - 900mm  
Pair back-to-back  
Blackbutt Hardwood



- A 400/600mm
- B 600/900mm
- C 42x32mm
- D 67mm

Black butt hardwood timber handles are supplied as raw unfinished timber allowing you the option to stain, varnish or clear coat the timber to achieve and compliment your desired styling theme.

3942 - 300mm | 3944 - 600mm  
Pair back-to-back  
Blackbutt Hardwood



- A 100/400mm
- B 300/600mm
- C 135x32mm
- D 67mm



# Iron Entrance Handles



Hand Crafted



**MB**  
53958  
Pair back-to-back  
Rustic - Black Textured

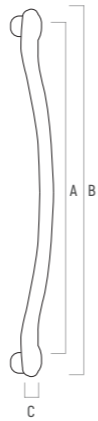

- A 612mm
- B 660mm
- C 8x40mm
- D 80mm Projection

Fixing Screws: M8  
FittingHoles:10mmdiameter



59217 myLOCK® Roller Entrance Lock  
53736 Escutcheon Snib Cover  
59144 Double Cylinder 65mm



73726 40x40mm Escutcheon Cover  
29144 Double Cylinder 65mm

**MB** 53955 Single Side  
**ATO BNZ** 73955 Single Side



- A 245mm
- B 400mm
- C 32x32mm
- D 65mm



**MB**  
53956  
Pair back-to-back  
Rustic - Black Textured



- A 515mm
- B 710mm
- C 30mm
- D 90mm Projection

Fixing Screws: M8  
FittingHoles:10mmdiameter



Off-Set Single Handle



- A 300mm
- B Width 26
- C Offset 56mm
- D Projection 54mm

**PB** 3953  
**ATO** 23953  
**PSS** 33953  
**SSS** 43953  
**MB** 53953

# Solid Cast 304 Entrance Handles

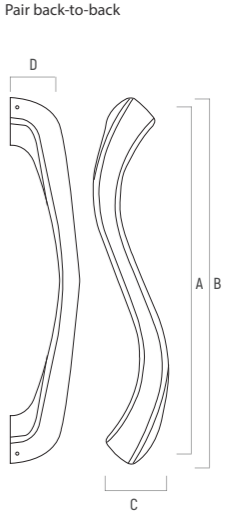

- A 350mm
- B 400mm
- C 24 x Offset 84mm
- D 82mm

Fixing Screws: M8  
Fitting Holes: 10mm diameter

Manufactured by Solid Investment Casting  
304 Stainless Steel  
Each pair weights 6kgs

<div style="border: 1px solid black; border-radius: 50%; width: 30px; height: 30px; display: flex; align-items: center; justify-content: center; margin: 0 auto;"> <span style="font-size: 10px; font-weight: bold;">304 SS</span> </div> <p style="font-size: 8px; margin-top: 5px;">304 STAINLESS STEEL</p>	PSS	33954
	MB	53954
	COP	63954
To Order		
WH		
To Order		
MD		



316 STAINLESS STEEL



MECHANICAL WARRANTY

# Sliding Or Barn Door Integrated Square Pull Handle & Flush Pull Set

304 SSS 43837 MB 53837

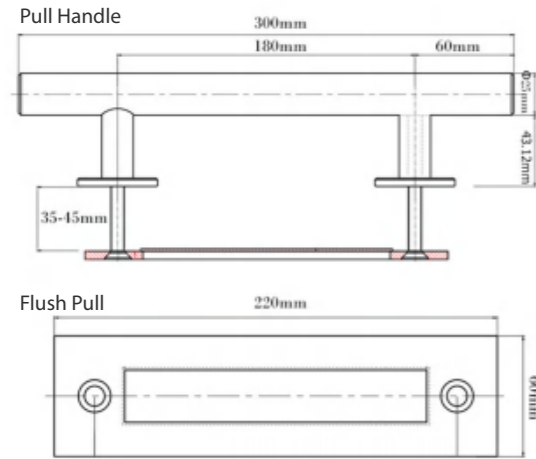

316 STAINLESS STEEL



To Order WH	To Order MD	To Order MB	CDP	PSS	316 SSS		A	B	C	D
		53885			43885	Single	300	275	25x50	65
		53886		33886	43886	Pair back-to-back	300	275	25x50	65
		53887		33887	43887	Single	500	475	25x50	65
		53888	63888	33888	43888	Pair back-to-back	500	475	25x50	65
		53890			43890	Pair back-to-back	800	775	25x50	65
		53890C			43890C	Pair back-to-back	1800	1775	25x50	65

Matching Snib & Escutcheon Cover Plates for your feature entrance door to maintain uniformity through out your home.



53888 Entry Pull Handle 500mmW  
59217 Entrance myLOCK  
53736 Snib & Escutcheon Cover Plate  
59144 Double Cylinder 60mm

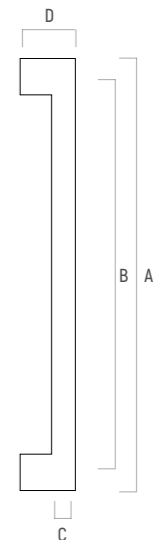

Used in conjunction with myLOCK entrance security locks and cylinders.

(Refer Security section).

# Aluminium



- 43966 Square Pull Handle
- 49204 Entrance Lock
- 43726 Square Escutcheon
- 49144 Double Cylinder



SC  
43966  
Pair back-to-back  
Aluminium

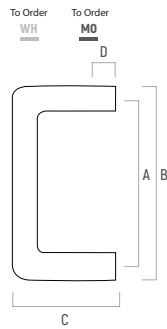

- 125mm Offset
- A 210mm
  - B 250mm
  - C 35 x Offset 125mm
  - D 61mm



SC  
43964  
Pair back-to-back  
Aluminium

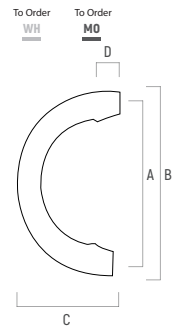

- 125mm Offset
- A 210mm
  - B 250mm
  - C 38 x Offset 125mm
  - D 61mm

# Glass



43933  
Single  
Tempered Clear Glass

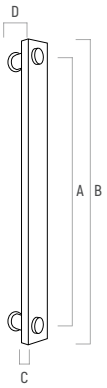

A 495mm  
B 550mm  
C 12x55mm  
D 54mm

43934  
Pair back-to-back  
Tempered Clear Glass

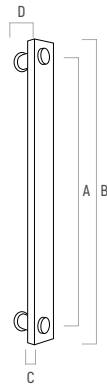

A 495mm  
B 550mm  
C 12x55mm  
D 54mm

43931  
Single  
Tempered Clear Glass

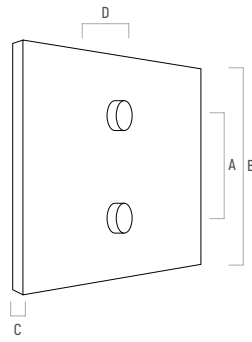

A 100mm  
B 170x170mm  
C 15mm  
D 55mm

43932  
Pair back-to-back  
Tempered Clear Glass

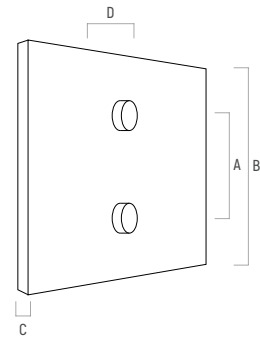

A 100mm  
B 170x170mm  
C 15mm  
D 55mm





Pair back-to-back

**304 SS**  
304 STAINLESS STEEL

A 573mm  
B 600mm  
C 38 x Offset 77mm  
D 70mm

Fixing Screws: M8 & M6  
Fitting Holes: 10mm diameter

**PVD**   **RED**   **MB**  
13972   63972   53972



**MB**  
53968  
Pair back-to-back  
Other Finishes available as a special order:  
**PSS**   **WH**   **MO**   **PVD**   **SSS**

**304 SS**  
304 STAINLESS STEEL

A 700mm  
B 1100mm  
C 38 x Offset 75mm  
D 80mm

Fixing Screws: M8  
Fitting Holes: 10mm diameter



53702 52mm Round Escutcheon  
59144 Double Cylinder 65mm



**Linear Entrance Pull Handle**  
Heavy Duty back to back thru fixing

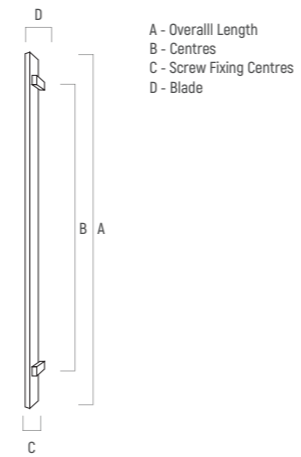

316 SSS		A	B	C	D
43816	Pair back-to-back	300	250	20x10	60
43817	Single	600	400	30x15	80
43818	Pair back-to-back	600	400	30x15	80
43820	Pair back-to-back	900	700	30x15	80

Other Finishes available as a special order:

- MB
WH
MD
PVD
SSS
PSS

- 43820 Handle
- 43707 Escutcheon
- 49144 Double Cylinder 65mm
- 49207 Roller Lock



**Circular Entry Pull Handle**  
Concealed Fix  
Includes 80mm Fixing Bolts

300mm Diam

- 53994 MB  
93994 SB



**Half Circle Entry Pull Handle**  
Concealed Fix  
Includes 80mm Fixing Bolts

300mm diam. 500mm diam. (Pictured)

- 53993 53992 MB  
93993 93992 SB



**"C" Semi Circle Entry Pull Handle**  
Concealed Fix  
Includes 80mm Fixing Bolts  
300mm diam.

- 53991 MB  
93991 SB





- 316SS Entrance Pull Handle 43814
- 316SS Lever Handle 42310
- 316SS Square Cover Plate 42329
- 304SS Escape Locks 49300
- 304SS Rebate Kit 49304
- Double Cylinder 49144
- Square Escutcheon 43726



316 SS		A	B	C	D
43808	Pair back-to-back	450	300	25x25	65
43810	Pair back-to-back	600	400	25x25	65
43812	Pair back-to-back	900	600	25x38	78
43814	Pair back-to-back	1200	900	25x38	78

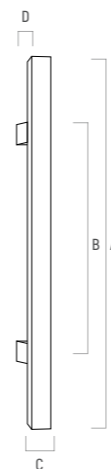

Other Finishes/Sizes available as a special order:

**MB** **WH** **MO** **PVD** **PSS**

Slim Design



316 SS		A	B	C	D
43824	Pair back-to-back	400	370	30x15	70
43828	Pair back-to-back	800	770	30x15	70

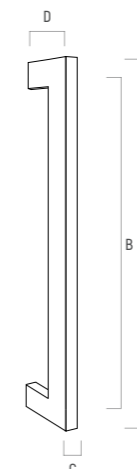

Other Finishes/Sizes available as a special order:

**MB** **WH** **MO** **PVD** **PSS**

Square Design



316 SS		A	B	C	D
43854	Pair back-to-back	450	425	25x25	66
43855	Pair back-to-back	600	575	25x25	66
43856	Pair back-to-back	1000	975	25x25	66

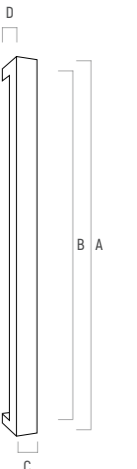

MB		A	B	C	D
53854	Pair back-to-back	450	425	25x25	66
53855	Pair back-to-back	600	575	25x25	66
53856	Pair back-to-back	1000	975	25x25	66

Other Finishes/Sizes available as a special order:

**PSS** **WH** **MO** **PVD**

Australian Standard  
AS-1428 Compliant





Oak Centre / Polished Ends

316 SSS	A	B	C	D
43910 Pair back-to-back	600	575	45	75

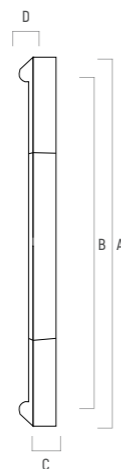

Satin Centre / Polished Ends

316 SSS	A	B	C	D
43916 Pair back-to-back	600	575	45	68

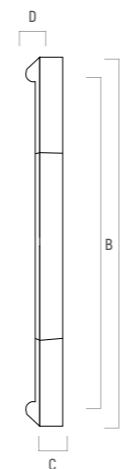

Bowed Pull

316 SSS	A	B	C	D
43869 Single	300	150	25	72
43870 Pair back-to-back	300	150	25	72
43874 Pair back-to-back	600	400	32	96
43876 Pair back-to-back	900	600	38	101

Other Finishes/Sizes available as a special order:  
**MB** **WH** **MO** **PVD** **PSS**

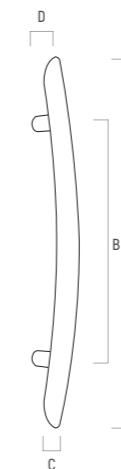

Linear Tube

316 SSS	A	B	C	D
43866 Pair back-to-back	450	300	25	63
43867 Single	600	400	32	74
43868 Pair back-to-back	600	400	32	74
43872 Pair back-to-back	1000	800	32	74
<b>MB</b>				
53866 Pair back-to-back	450	300	25	63
53868 Pair back-to-back	600	400	32	74
53872 Pair back-to-back	1000	800	32	74
<b>SB</b>				
93866 Pair back-to-back	450	300	25	63
93868 Pair back-to-back	600	400	32	74

Other Finishes/Sizes available as a special order:  
**PSS** **WH** **MO** **PVD**

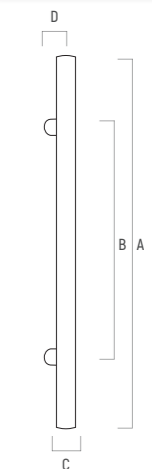



316 STAINLESS STEEL



316 STAINLESS STEEL



43846



43882

Australian Standard AS-1428 Compliant



4382

43834 300mm  
43737 Integrated Round Snib & Escutcheon Set  
Used with 49211 myLock



43924

### Ergonomic Pull

316 SSS		A	B	C	D
43846	Pair back-to-back	450	300	32	78
43848	Pair back-to-back	600	300	32	78
43850	Pair back-to-back	900	600	38	78
43852	Pair back-to-back	1200	900	38	78



Other Finishes/Sizes available as a special order:

MB WH MO PVD PSS

### Standard "D" Pull

316 SSS		A	B	C	D
43881	Single	350	325	25	74
43882	Pair back-to-back	350	325	25	70
43883	Single	600	562	38	90
43884	Pair back-to-back	600	562	38	90

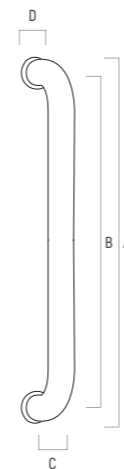

Other Finishes/Sizes available as a special order:

MB WH MO PVD PSS

### Offset "D" Pull

316 SSS		A	B	C	Offset	E Projection
43833	Single	300	268	32	112	77
43834	Pair back-to-back	300	268	32	112	77
43842	Pair back-to-back	600	568	32	136	77
43843	Single	1300	1268	32	112	81
43844	Pair back-to-back	1300	1268	32	112	81

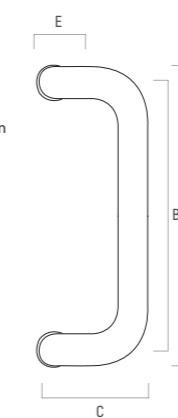

Other Finishes/Sizes available as a special order:

MB WH MO PVD PSS

### Offset Tube Pull

Offset 100mm

316 SSS		A	B	C	D
43921	Single	350	220	32	80
43922	Pair back-to-back	350	220	32	80
43924	Pair back-to-back	600	400	32	80

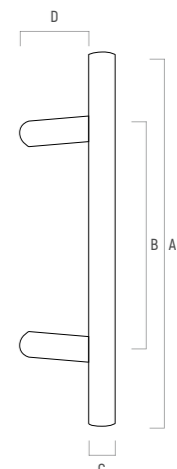

Other Finishes/Sizes available as a special order:

MB WH MO PVD PSS



316 STAINLESS STEEL



316 SSS 43997



SB 93996

### Linear Square Design

Pair back-to-back

WH	SB	MB	316 SSS	A	B	C
83995	93995	53995	43995	450	430	20x40
83996	93996	53996	43996	600	580	20x40
		53997	43997	1000	980	20x40

Narrow Face

MB	316 SSS	A	B	C
53998	43998	450	430	15x30
53998	43999	600	585	15x30



MB 53926



316 SSS 43928

### Tapered Design

Pair back-to-back

316 SSS	A	B	C
43926	325	300	28x12.5
43928	475	450	28x12.5
43929	625	600	28x12.5
43930	1025	1000	28x12.5

MB	316 SSS	A	B	C
53926	325	300	28x12.5	
53928	475	450	28x12.5	
53929	625	600	28x12.5	
53930	1025	1000	28x12.5	

SB	316 SSS	A	B	C
93928	475	450	28x12.5	
93929	625	600	28x12.5	



316 STAINLESS STEEL



WH 83830

MB 53840 80mm offset



Australian Standard AS-1429 Compliant

### Square Offset Design

Pair back-to-back

MB	WH	316 SSS	A	B	C	D
53830	83830	43830	600 / cc575	120	25x25	50

316 SSS	A	B	C	D
43840/325	325 / cc300	80	25x25	50
43840/475	475 / cc450	80	25x25	50
43840/625	625 / cc600	80	25x25	50

MB	A	B	C	D
53840/325	325 / cc300	80	25x25	50
53840/475	475 / cc450	80	25x25	50
53840/625	625 / cc600	80	25x25	50

Other Finishes/Sizes available as a special order.

PVD WH MQ

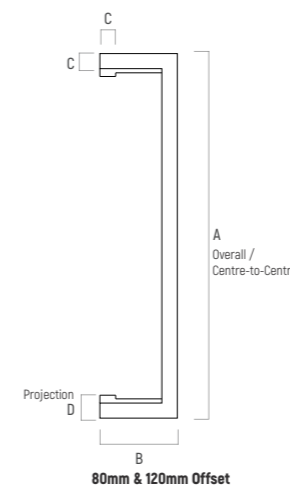

316 SSS 43960



MB 53960

### Slim Offset Design

Pair back-to-back

316 SSS	A	B	C	D	E	F
43960	450	425	100	50	30x15	30x30

MB	A	B	C	D	E	F
53960	450	425	100	50	30x15	30x30

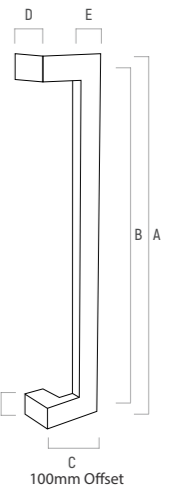

# Aluminium



# Solid Brass



## Pull Handle Accessories

### Magnetic Door Catch

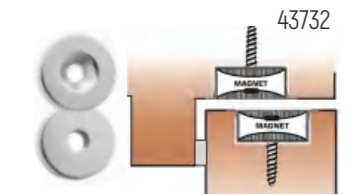

Earth magnets recessed into the frame and door hold the door firmly and securely in the closed position.

### Roller Catch Latch

- CP 39026
- SC 49026
- MB 59026



Roller Latch assists to hold the door firmly and securely in the closed position.

### Pull Handle Fixing Legs

2 pcs  
DIY Fixing legs accessory can be attached to timber or aluminium handles



- SC 49878
- MB 59878

### Blade Sliding Door Handle

Pair back-to-back  
Projection 40mm

SSS	A	B	C
43940	450	420	40x15

MB 53940

SB 93940

Other Finishes/Sizes available as a special order:

PVD WH MO



### Blade Pull Handle

Pair back-to-back  
Projection 40mm

SSS	A	B	C
43936	450	420	40x15

MB 53936

SB 93936

Other Finishes/Sizes available as a special order:

MO WH PSS

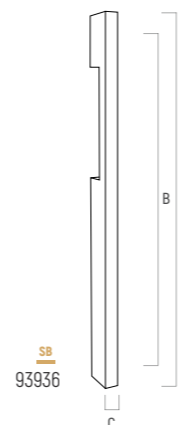

### Single Square Pull Handle

Heavy duty thru fixing

	A	B	P
PB 3183	100	100	60
CP 33183	100	100	60
SC 43183	100	100	60
MB 53183	100	100	60

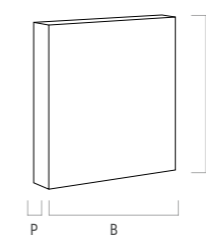

# Sliding Door - Integrated Flush Pull & Handle



304  
STAINLESS STEEL



DURABLE  
SECURITY



INTEGRATED  
PRIVACY OPTION

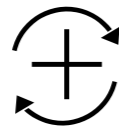

INTEGRATED  
KEYLESS SNIB LOCK



INDEPENDENT  
CAM OPERATION



myLOCK



## myLOCK

Integrated Sliding Door Entrance Lock  
Privacy & Dead Bolt Functionality  
30mm Backset / 47mm Overall

49285 SSS  
59285 MB

### Striker Plate Options Included

- Fixings suit aluminium & timber 40mm+ doors.
- Flush and face fix options.

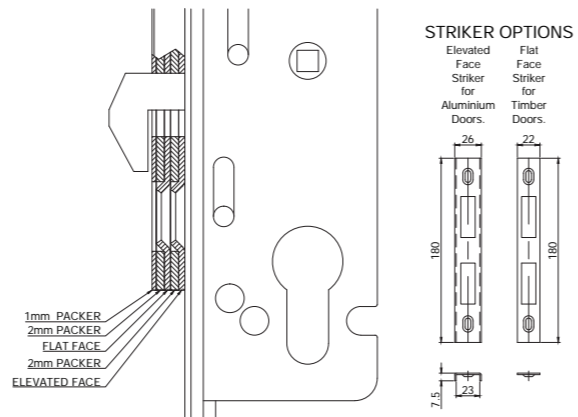

- 180x26mm  
1x Boxed Elevated Finishing Striker
- 180x22mm:  
1x Flat Finishing Striker  
2x 2mm Packing Plates  
1x 1mm Packing Plate



### Rectangle Escutcheon Cover

Concealed Fixing  
304 Stainless Steel  
70x30x9mm

43724 SSS  
53724 MB



## myLOCK Integrated Flush Pull & Handle

Back to back fixing  
Integrated keyless privacy & high security dead lock

Flush Pull: 295x40mm (C/C 275mm)  
Full Handle: 25x25x300mm (C/C 275mm)

43967 SSS  
53967 MB



## myLOCK Integrated Flush Pull & Slim Linear Handle

Back to back fixing  
Integrated keyless privacy & high security dead lock

Flush Pull: 295x40mm (C/C 275mm)  
Full Handle: 30x15x305mm (C/C 275mm)

43969 SSS  
53969 MB



## myLOCK Integrated Back To Back Flush Pull Set

Back to back concealed fixing  
Concealed External Fixing  
Integrated keyless privacy & high security dead lock

Flush Pull: 295x40mm (C/C 275mm)

43756 SSS  
53756 MB





## Security



**ALL IN ONE Integrated Security:  
ROLLER LATCH, PRIVACY and DEAD BOLT.**

Upgrade & Improve Your Entrance Security Without Changing Your Door.  
The new stainless steel body is designed to retro fit into the cavity of 85mm entrance mortice locks.  
Upgrade the security in your home without the need to change your door.

**304 Stainless Steel**  
The casing, privacy & dead bolts, roller latch, spindle follower, internal components, faceplates and striker plates are manufactured in 304 high grade stainless steel for superior durability.

**The Indicator Snib**  
The direction of the snib provides a visual reference to indicate whether the privacy bolt (and the door) is in the locked or unlocked position.

**Adjustable SS Heavy Duty Roller Latch**  
After installation from the front of the roller latch; easily adjust the spring tension and projection of the roller to suit your desired opening tension.

suits austyle independent CAM cylinders only

**Keyless Locking**  
Using the snib when home will prevent anyone opening the door and walking in. It's a quick and simple locking function for every day use and works independently of the dead bolt.

**High Security Dead Bolt**  
Engage the dead bolt for the ultimate level of security when you're out of the house or away on holiday. A solid 304SS bolt that is 40mm high and 10mm thick and extends 85mm across the door jamb and back into the case will give you security and peace of mind.

**Independent CAM Cylinder & Integrated keylock**  
The independent CAM cylinder allows you to leave your key in the cylinder while still allowing its use from the outside of the door. Using your key to enter will simultaneously disengage both the privacy and dead bolt so you can enter in auSTYLE.



myLOCK Roller Lock

	60mm Backset	30mm Backset	Rebate Kit Option	Face/Striker Spare Parts 60mm
PVD	19217		19220	19827
ATO	29217		29220	29827
PSS	39217		39220	39827
SSS	49217	49214	49220	49827
MB	59217	59214	59220	59827
COP	69217			69827



## HOW TO ORDER

The 4 step process helps you combine the Roller Lock with the appropriate auStyle product to create a modern, clean entrance feature.

**STEP 1**  
Choose myLOCK Roller Lock x9217 or x9214  
Add rebate kit if needed

**STEP 2**  
Choose Your Entrance Handle  
See Feature Pull Handles P.37

**STEP 3**  
Choose Your Snib Escutcheon Design  
See Security Secion P.75

**STEP 4**  
Choose Your Cylinder Type  
Requires a double cylinder

suits austyle independent CAM cylinders only  
Cylinders P.72



**ALL IN ONE Integrated Security:  
LEVER LATCH, PRIVACY and DEAD BOLT.**

Upgrade & Improve Your Entrance Security Without Changing Your Door.  
The new stainless steel body is designed to retro fit into the cavity of 85mm entrance mortice locks.  
Upgrade the security in your home without the need to change your door.

**304 Stainless Steel**  
The casing, privacy & dead bolts, latch, spindle follower, internal components, face plates and striker plates are manufactured in 304 high grade stainless steel for superior durability.

**The Indicator Snib**  
The direction of the snib provides a visual reference to indicate whether the privacy bolt (and the door) is in the locked or unlocked position.

**Quick Release Escape Function**  
Using the lever handle to open the door automatically disengages the privacy bolt for a quick keyless exit.

2 Hour Fire Tested Lock  
2 Hour Fire Rated Cylinders

**Keyless Locking**  
Using the snib when home will prevent anyone opening the door and walking in. It's a quick and simple locking function for every day use and works independently of the dead bolt.

**High Security Dead Bolt**  
Engage the dead bolt for the ultimate level of security when you're out of the house or away on holiday. A solid 304SS bolt that is 40mm high and 10mm thick and extends 85mm across the door jamb and back into the case will give you security and peace of mind.

**Independent CAM Cylinder & Integrated keylock**  
The independent CAM cylinder allows you to leave your key in the cylinder while still allowing its use from the outside of the door. Using your key to enter will simultaneously disengage both the privacy and dead bolt so you can enter in auSTYLE.

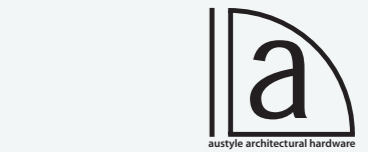

myLOCK Lever Lock

	60mm Backset	30mm Backset	Rebate Kit Option	Face/Striker Spare Parts 60mm
PVD	19219	19211	19220	19828
ATO	29219		29220	29828
PSS	39219	39211	39220	39828
SSS	49219	49211	49220	49828
MB	59219	59211	59220	59828
COP	69219			69828



## HOW TO ORDER

The 3 step process helps you combine the Lever Lock with the appropriate auStyle handle set to create a modern, clean entrance feature.

**STEP 1**  
Choose myLOCK Latch Lock x9219 or x9211  
Add rebate kit if needed

**STEP 2**  
Choose Your Entrance Lever  
DETERMINING THE HANDING  
Standing on the INSIDE and facing the door... Which way is the lever pointing?  
Left Hand xxxxM-LH  
Right Hand xxxxM-RH  
See Door Handles Section P.19

**STEP 3**  
Choose Your Cylinder Type  
Requires a double cylinder

suits austyle independent CAM cylinders only  
Cylinders P.72

# 4 QuadLock

## Multi Function Entrance Lock ALL IN ONE 4 Modes of Operation

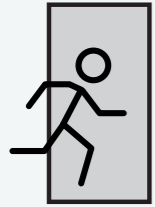

### Entrance Lock With Full Escape Function

Internal: Lever Handle retracts the latch and bolt simultaneously for emergency exit.  
External: Lever Handle operates the latch to enter. Use a key to un/lock the bolt.

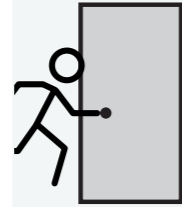

### Entrance Lock Non-Escape Function

Internal: Lever Handle operates the latch to exit. Use a key to un/lock the bolt.  
External: Lever Handle operates the latch to enter. Use a key to un/lock the bolt.



304 STAINLESS STEEL



LATCHING STRIKER OPTION INCLUDED



4

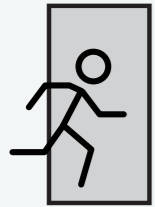

### Fire Escape or Electric Strike Function

Fire Door Exit Compliance  
Electric Strike Compatible

Disable the bolt so only the dead latch escape option is enabled.  
Internal: Lever handle retracts the latch for emergency exit.  
External: Use a key to retract the latch.

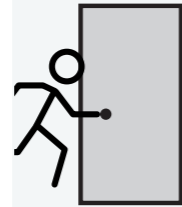

### Passage Latch Function

Disable the bolt and escape function so the lock operates as a passage door latch.



#### Handle Features:



#### QuadLock Features:

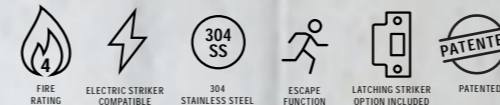

#### Cylinder Features:

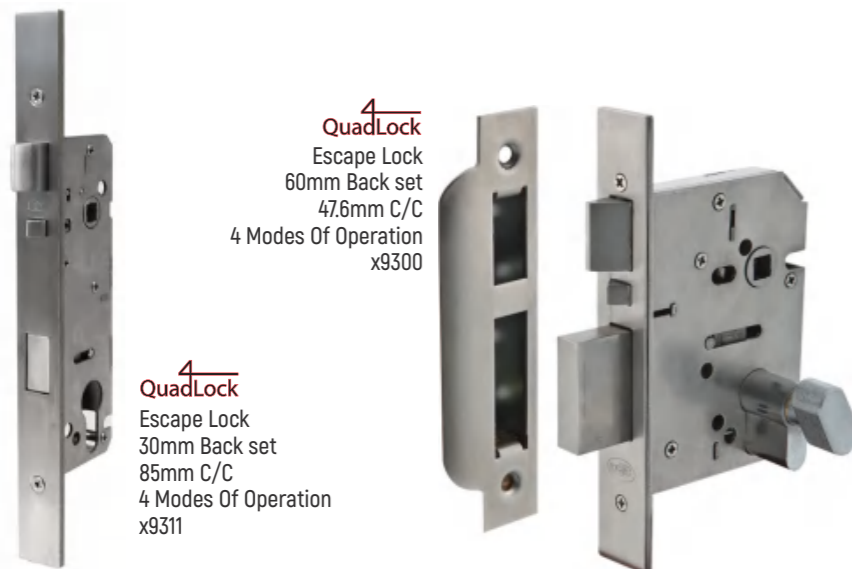

4 QuadLock  
Escape Lock  
60mm Back set  
47.6mm C/C  
4 Modes Of Operation  
x9300

4 QuadLock  
Escape Lock  
30mm Back set  
85mm C/C  
4 Modes Of Operation  
x9311

	60mm Backset	Rebate Kit Option 60mm	Face/Striker Spare Parts 60mm	30mm Backset
PVD	19300	19304	19825	19311
ATO	29300	29304		
PSS	39300	39304	39825	39311
SSS	49300	49304	49825	49311
MB	59300	59304	59825	59311

Rebate Kit Available x9304



Flat Latch Striker Plate  
Option Included with both  
Escape Locks

# 4 QuadLock

# Security Locks Hinged Doors



Designed and Engineered in Australia

Heavy duty case and internal mechanical components.

Non combustible components

## Residential Security Locks

Simultaneously retracts latch when unlocking the door for a quick exit  
Reversible latch for either LH / RH opening doors



	45mm Backset	60mm Backset	Rebate Kit Option
<b>PB</b>	9208	9209	19210
<b>PSS</b>	39208	39209	39210
<b>SSS</b>	49208	49209	49210
<b>MB</b>	59208	59209	59210

## Commercial Narrow Back Set

85mm C/C



	25mm Backset	30mm Backset	Rebate Kit Option
<b>SSS</b>	49200	49201	49210
<b>MB</b>	59200	59201	59210

**QuadLock**  
Refer P56 For Function Options

	30mm Backset					
<b>PVD</b>	19311					
<b>PSS</b>	39311					
<b>SSS</b>	49311					
<b>MB</b>	59311					

**QuadLock**

Refer P56 For Function Options



## Commercial Dead Latching Locks

Fire Door Exit Compliance when installed & used in dead latching mode  
Electric Strike Compatible when installed & used in dead latching mode  
Simultaneously retracts latch (and bolt) when unlocking the door for a quick exit

Reversible latch for either LH / RH opening doors

47.6mm C/C



	60mm Backset	Rebate Kit Option 60mm	Face/Striker Spare Parts 60mm	Flat Latch Striker Plate Option Included
<b>PVD</b>	19300	19304	19825	
<b>ATQ</b>	29300	29304		
<b>PSS</b>	39300	39304	39825	
<b>SSS</b>	49300	49304	49825	
<b>MB</b>	59300	59304	59825	

	60mm Backset	Rebate Kit Option
<b>SSS</b>	49301	49304

### WHY ARE AUSTYLE 304 STAINLESS STEEL SECURITY LOCKS BETTER?

Simply put, stainless steel offers significantly better durability and strength when compared with commonly available zinc or steel structured locks. Stainless steel contains higher levels of nickel providing superior corrosive resistance. Our locks are ideal for heavy duty, commercial applications and whenever superior quality and reliability is a significant consideration.



## Extended Striker Plates



	SSS	PSS
<b>Generic Extension Striker 100x25mm</b>	49839	39839



Suits All 85mm Locks

	304 SSS
<b>49840</b>	85mm - 60mm Extension Lip
<b>49841</b>	125mm - 60mm Extension Lip

Suits Roller Locks  
49842 125mm - 60mm Extension Lip

	MB
<b>59840</b>	85mm - 60mm Extension Lip
<b>59841</b>	125mm - 60mm Extension Lip

Suits Roller Locks  
59842 125mm - 60mm Extension Lip

## Metal Frame Flush Fixings

Flush Fix Mounting Tabs Enable Locks To Be Flush Fixed Into Metal Frame Doors.



#9865 (1pair)  
50x25x10mm  
2 Optional Steps For Varying Face Plate Thicknesses (1mm & 2.5mm)

# Roller Latch Entrance Security



## Roller Latch & dead bolt - Timber Doors

Adjustable roller spring tension  
Supplied with both LH and RH striker plates  
Used in conjunction with entry handles, cylinders and escutcheons

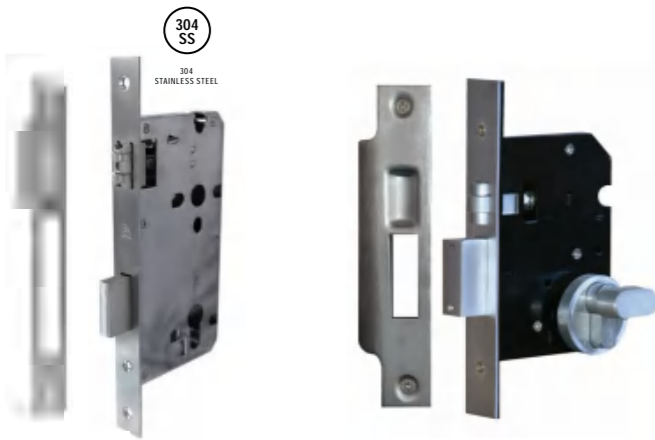

45mm Backset	60mm Backset	Rebate Kit Option 60mm	57mm Backset	Escutcheon /cylinder sold separately
SSS 49206	49207	49210	PB 9015	
MB 59206	59207	59210	ATQ 29015	
			PSS 39015	
			SSS 49015	
			MB 59015	

## Roller Latch & dead bolt - Aluminium Doors

From adjustable roller spring tension  
Heavy duty aluminium or timber door commercial applications  
Supplied with both LH and RH striker plates



30mm Backset	60mm Backset	Rebate Kit Option 60mm Only
SSS 49214	PVD 19217	19220
MB 59214	ATQ 29217	29220
	PSS 39217	39220
	SSS 49217	49220
	MB 59217	59220
	CDP 69217	

## Self Latching Snib Latches

**Sliding Doors**  
Ideal for all Aluminium or timber self closing/latching sliding doors  
Residential or commercial applications



Disabled & Child safety latch  
Install at 1800mm from floor to prevent children opening doors



Includes 2 snibs 45mm diameter /28mm Backset

PVD	19027
PSS	39027
SSS	49027
MB	59027

**Hinged Doors**  
Ideal for all self closing/latching hinged doors  
Residential or commercial applications



Disabled & Child safety latch  
Install at 1800mm from floor to prevent children opening doors



Includes 2 snibs 40mm diameter / 60mm Backset

PVD	19018
PSS	39018
SSS	49018

# Sliding Doors Security



## Sliding Cavity Door Lock

Designed and Engineered in Australia  
Heavy duty case and internal mechanical components.  
Non combustible components  
Heavy duty steel striker plate for additional strength and security  
Solid stainless steel Bolt and Latching Mechanism

### 45mm back set



Euro Cylinder	5 Lever Skeleton Key
PB 9087	9084
ATQ	29084 Plated to order
PSS	39084 Plated to order
SSS 49087	49084 Plated to order
MB 59087	59084 Plated to order

### myLOCK

Integrated Keyless Privacy and High Security Dead Bolt Functionality.  
Stainless Steel Non-combustible components  
Heavy duty steel backing plate for additional strength and security

### 30mm back set

Multiple Striker Options.  
Suits Timber & Aluminium Doors  
Included for Flush & Face Fixing options

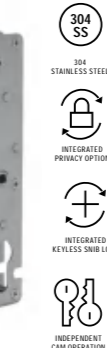
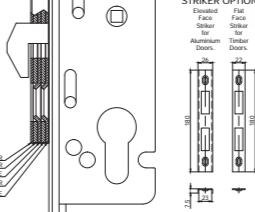

30mm Backset	
PVD	19285
PSS	39285
SSS	49285
MB	59285

## Entrance Dead Bolt 304SS

Heavy duty steel backing plate for additional strength and security  
Suitable for either LH or RH opening doors  
(49143 cylinder / 43702 escutcheon sold separately)

### 60mm back set



Euro Cylinder	
PB	19312
ATQ	29312
PSS	39312
SSS	49312
MB	59312



## Door Edge Pull

Use the edge pull to retrieve the door from its cavity.



SSS	44455
MB	54455
SB	94455



Heavy Duty Pull Handle

115x25mm	
PB	4456
CP	34456
SC	44456
MB	54456

## Integrated Flush Pull for entrance sliding doors

For fully recessed doors, use x3754E flush pulls together with a x9140 42mm cylinder on cavity sliding door with an entrance sliding door lock to allow the door to fully recess back into its cavity without compromising on security.

Flush Pull 220x55x10mm	
SSS	43754E
MB	53754E

Cylinder 42mm Double	
SSS	49140
MB	59140

Sliding Door Lock (refer above)	
SSS	49087
MB	59087

# Security Cylinders

## Keyed Cylinder Barrels

C4 euro profile  
Available keyed alike - free of charge (ex stock SC only)  
Approved for master keying  
S/Steel internal springs for durability and reliability

	39mm 3 Pin Single Cyl.	42mm 3 Pin Double	60mm 5 Pin Double	65mm 5 Pin Double	70mm 5 Pin Double	80mm 5 Pin Double	100mm 5 Pin Double	120mm 5 Pin Double
<b>39mm Single</b>								
<b>42mm Double</b>	PVD PB 9142	-	19143	19144	-	-	-	-
<b>60mm Double</b>	ATQ 29142	-	29143	29144	-	-	-	-
<b>65mm Double</b>	CP 39142	-	39143	39144	39147	39148	39150	-
<b>80mm Double</b>	SC 49142	49140	49143	49144	49147	49148	49150	49151
<b>100mm &amp; 120mm Double</b>	MB 59142	59140	59143	59144	59147	59148	59150	59151
	WH			89144				
	SB			99144				

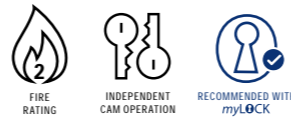

## Turn Snib & Key Cylinder Barrels

	39mm Cyl. & Turn	65mm 5 Pin Cyl. & Turn	70mm 5 Pin Cyl. & Turn
<b>39mm Cyl. &amp; Turn</b>			
<b>65mm Cyl. &amp; Turn</b>	PVD PB 9141	19145	-
<b>70mm Cyl. &amp; Turn</b>	ATQ -	29145	-
	CP 39141	39145	-
	SC 49141	49145	49149
	MB 59141	59145	59149



## Euro Profile Privacy Adapter

Use the adaptor to convert any of the high security locks to use with privacy snibs for low security privacy or bathroom door applications. Refer page 77 for all available snib styles.

Euro Profile Privacy Adapter  
9848



When using with long plate furniture, Please specify the privacy spacing position required to suit either 47.6mm or 85mm C/C locks as follows:

PRIVACY 47.6mm C/C XXXXPA	PRIVACY 85mm C/C XXXXPE
------------------------------	----------------------------

## Key Blanks

Cylinder Keys  
9845-KEY5 5 Pin  
9845-KEY6 6 Pin

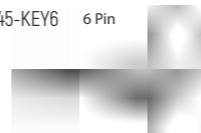

# Passage Door Latches



## Passage Latch heavy duty "D" Strike



	60mm Single Spring	60mm Double Spring
PB	9031	9030
ATQ	29031	29030
CP	39031	39030
SC	49031	49030
MB	59031	59030
COP	69031	

## Separate Rebate adaptor kit



PB	9025
ATQ	29025
CP	39025
SC	49025
MB	59025

Suits Austyle Latches & Privacy Bolts

## Passage Latch "T" Striker

Split Follower



	45mm Single Spring	60mm Single Spring
PB	9028	-
ATQ	-	-
CP	39028	-
SC	49028	49028
MB	59028	-

## Magnetic Latch for a clean door edge



60mm Depth  
50mm Backset  
The magnet ejects & retracts automatically with the operation of the handle. Includes box striker for a neat professional finish.

SC 49024

# Passage Door Catches



## Roller Catch Latch



Roller Latch assists to hold the door firmly and securely in the closed position.

CP	39026
SC	49026
MB	59026

## Magnetic Door Catch

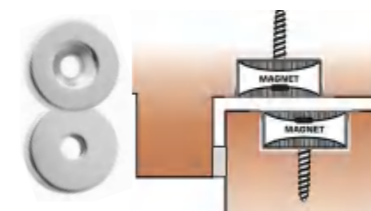

Earth magnets recessed into the frame and door hold the door firmly and securely in the closed position.

SC 43732

**TIP:** Highly Recommended for use on all pivot or hinged doors where a roller lock is installed to assist in holding the door firmly in position.

## Ball Catch/Latch



Ball catch assists to hold the door firmly and securely in the closed position.

PB	3731
CP	33731
SC	43731

# Escutcheon Covers



Cylinder sold separately

Rectangle Concealed  
70x30mm  
9mm Projection

<b>304 SS</b>	<b>PVD</b>	13724
<b>304 STAINLESS STEEL</b>	<b>PSS</b>	33724
	<b>SSS</b>	43724
	<b>MB</b>	53724
	<b>WH</b>	83724

Oval Concealed  
70x30mm  
9mm Projection

<b>304 SS</b>	<b>PVD</b>	13725
<b>304 STAINLESS STEEL</b>	<b>PSS</b>	33725
	<b>SSS</b>	43725
	<b>MB</b>	53725
	<b>WH</b>	83725



Square Edge 52mm 8mm Projection	Square Edge 45mm 8mm Projection	Square Edge 45mm 8mm Projection	
<b>PB</b>	3702	3701	3700
<b>ATO</b>	23702	23701	-
<b>CP</b>	33702	33701	33700
<b>SC</b>	43702	43701	43700
<b>MB</b>	53702	53701	53700
<b>WH</b>	83702	83701	83700
<b>SB</b>	93733		



Square 40x40mm 8mm Projection	
<b>PB</b>	3726
<b>ATO</b>	23726
<b>CP</b>	33726
<b>SC</b>	43726
<b>MB</b>	53726
<b>WH</b>	83726



**316 SS**  
316 STAINLESS STEEL

Square Edge  
52mm  
8mm Projection  
Concealed Fix  
Solid Cast 316SS

<b>316 SSS</b>	43704
----------------	-------



Rounded Edge  
52mm  
8mm Projection

<b>PVD</b>	13703
<b>CP</b>	33703
<b>SC</b>	43703
<b>MB</b>	53703



Square Oval Profile  
52x52mm  
8mm Projection  
Concealed Fix

<b>SC</b>	43537
<b>MB</b>	53537



Blank  
Concealing Cover  
52mm  
8mm Projection

<b>CP</b>	33709
<b>SC</b>	43709
<b>MB</b>	53709



Square  
Oval Cyl.  
50x50mm  
8mm Projection

<b>SC</b>	43537
<b>MB</b>	53537



Square Euro Profile  
52x52mm  
8mm Projection  
Concealed Fix

<b>SC</b>	43538
<b>MB</b>	53538



Square Edge  
Oval Cyl.  
8mm Projection

52mm	45mm	40mm	
<b>PVD</b>	13707	13706	13705
<b>CP</b>	33707	33706	33705
<b>SC</b>	43707	43706	43705
<b>MB</b>	53707	53706	53705
<b>WH</b>	83707	83706	83705



Round Edge  
Oval Cyl.  
8mm Projection

52mm	
<b>PVD</b>	13708
<b>CP</b>	33708
<b>SC</b>	43708
<b>MB</b>	53708
<b>WH</b>	83708

## Finishing Options: Integrated "Keyless" Snib & Escutcheon



Create a clean minimal entrance using a snib & escutcheon set to operate high security locks for front/external doors.

The snib operates the lock in the same way a conventional lever handle functions, opening the door from the inside with a turn of the snib.

Externally, use a key to simultaneously retract the latch and open the door.

Simple. Practical daily functionality.



## Snib & Escutcheon Sets

304 Stainless Steel Plates. 145x40mm. Includes external escutcheon plate. Cylinders sold separately p.72.



**4 QuadLock**  
Suits: x9300  
Lever Locks  
(p.68)  
47.6mm

**myLOCK**  
Suits: x9217  
Roller Locks  
(p.70)  
85mm

13735	<b>PVD</b>	13736	<b>PVD</b>
23735	<b>ATO</b>	23736	<b>ATO</b>
33735	<b>PSS</b>	33736	<b>PSS</b>
43735	<b>SSS</b>	43736	<b>SSS</b>
53735	<b>MB</b>	53736	<b>MB</b>
63735	<b>CP</b>	63736	<b>CP</b>
		83736	<b>WH</b>
		93736	<b>SB</b>

Round Integrated Snib Set  
45mm diameter

**myLOCK**  
Suits: x9217  
85mm



23737	<b>ATO</b>
43737	<b>SSS</b>
53737	<b>MB</b>

Rectangle Integrated Snib Set  
100x40mm

**myLOCK**  
Suits: x9217  
85mm



23734	<b>ATO</b>
43734	<b>SSS</b>
53734	<b>MB</b>

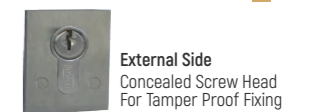

External Side  
Concealed Screw Head  
For Tamper Proof Fixing

# Bathroom Locking Options

## Recessed Cavity Sliding Door Options

Ideally used in situations where the cavity door recesses all the way back inside the door frame. These flush pulls are recessed into the door face allowing the door to fully recess into its cavity. Matching flush pulls for lockable and passage doors available on page 41 for aesthetic consistency.

### Integrated privacy flush pull



43754P

### Non-Recessed snibs



59038 & 59033

### Recessed flush turn snibs

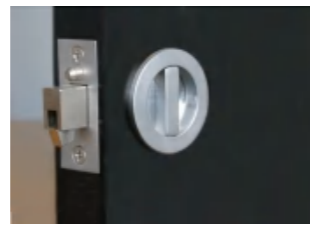

Refer opposite page for all snib style options  
Locating pin guides the door into its correct position when closing.



Concealed Fix Flush Turn Snib Set 40mm Diam		Sliding Door Latch 53mm Overall 37mm C/C
<b>PVD</b>	9040	9033
<b>ATO</b>	29040	29033
<b>CP</b>	39040	39033
<b>SC</b>	49040	49033
<b>MB</b>	59040	59033

# Hinged Bathroom Door Options

Bathroom Privacy Door Bolt 60mm back set

- 9032 **PVD**
- 29032 **ATO**
- 39032 **PSS**
- 49032 **SSS**
- 59032 **MB**
- 69032 **CDP**



Used in conjunction with all snib options below.

## Privacy Snib Styles

Ideal for hinged or sliding doors / concealed & thru fix options / Ideal for semi-recessed sliding doors



Square Concealed Fix  
40x40mm

- CP** 9046
- SC** 49046
- MB** 59046



Round Concealed Concealed Fix  
50mm diam.

- SC** 43531CL
- MB** 53531CL



Round Concealed Fixing  
36m Diam.

- PB** 9038
- ATO** 29038
- CP** 39038
- SC** 49038
- MB** 59038



Rectangle Snib Set Thru Fixing  
40x25m Diam.

- PB** 9034
- ATO** 29034
- CP** 39034
- SC** 49034
- MB** 59034



Square Double Snib Set  
Concealed Fixing  
40x40mm

- SC** 49045
- MB** 59045

## Bathroom Indicator Bolts

Latch  
40mm x 68mm



- CP** 39014
- SC** 49014

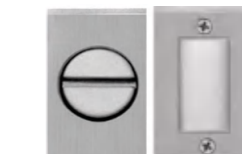

Rectangle Semi Concealed Fix  
42x25mm

- PB** 9037
- CP** 39037
- SC** 49037
- MB** 59037



Square Concealed Concealed Fix  
50x50mm

- SC** 43531CL
- MB** 53531CL



Ideal for cavity sliding doors  
Concealed Fixing  
45m Diam.

- PB** 9040
- CP** 39040
- SC** 49040
- MB** 59040
- SB** 99040



Round Snib Set Thru Fixing  
45m Diam.

- PB** 9035
- ATO** 29035
- CP** 39035
- SC** 49035
- MB** 59035



Round Double Snib Set  
Concealed Fixing  
40m Diam.

- PB** 9044
- CP** 39044
- SC** 49044
- MB** 59044



53754P



Integrated Flush Pull & Latch Set Flush Pull 220x55mm Includes 60mm Latch		Sliding Door Latch (Only) 60mm Back Set 80mm Overall
<b>304 SSS</b>	43754P	49041
<b>MB</b>	53754P	59041

### Bathroom Sliding Door



Flush Pull	Flush Latch Pull
<b>PB</b> 9049	9050
<b>ATO</b> 29049	29050
<b>CP</b> 39049	39050
<b>SC</b> 49049	49050
<b>MB</b> 59049	59050



### FEATURES:

- Entrance, Privacy & Passage Functions
- Suitable for 35-45mm door thickness
- Solid diecast construction 178x38mm
- Includes door edge finger pull
- Adjustable striker plate
- Integrated emergency release (privacy)
- 3 Keys included (entrance)
- Includes fixing instructions
- Finishes: Black; Satin Nickel; Satin Brass
- Passage Doors 43757-SN 53757-Black 93757-Satin Brass
- Privacy Doors 43758-SN 53758-Black 93758-Satin Brass
- Entrance Doors 43759-SN 53759-Black 93759-Satin Brass



Privacy  
Reverse Side colour indicator & emergency release



Passage



Entrance  
Reverse Side colour indicator & emergency release





## Flush Pulls

# Flush Pulls

304  
SS

304  
STAINLESS STEEL

Ideal for all bi-fold  
Sliding or cavity doors



70x70mm 50x50mm  
12mm Depth 12mm Depth

304 SSS	43750	43751
<b>MB</b>	53750	53751



70x70mm  
12mm Depth

304 SSS	43742
<b>MB</b>	53742



90mm Diam.  
19mm Depth

304 SSS	43743
<b>MB</b>	53743



65mm Diam.  
12mm Depth

304 SSS	43741
<b>MB</b>	53741



Used in conjunction with  
passage latch (x9031) and  
most 60mm backset locks.

76mm Diam.  
14mm Depth

304 SSS	43746
<b>MB</b>	53746



45x63mm  
7mm Depth

PSS	33747
304 SSS	43747
<b>MB</b>	53747

Longer architectural sizes assist to accentuate the height of the door and room.  
Ideal for timber or aluminium doors.

<b>320x55mm</b> 12mm Depth	<b>220x55mm</b> 12mm Depth	<b>150x50mm</b> 12mm Depth	<b>100x50mm</b> 12mm Depth
304 SSS 43753	304 SSS 43752	304 SSS 43749	PSS 33745
<b>MB</b> 53753	<b>MB</b> 53752	<b>MB</b> 53749	304 SSS 43745
		WH 83749	<b>MB</b> 53745
		SB 93749	

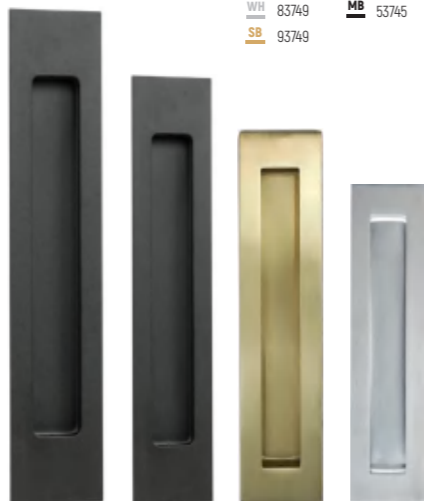

304  
SS

304  
STAINLESS STEEL Concealed fixing with an internal finger grip



**100x50mm**  
12mm Depth

PSS	33745
304 SSS	43745
<b>MB</b>	53745

**150x50mm**  
12mm Depth

304 SSS	43749
<b>MB</b>	53749
SB	93749

**220x55mm**  
12mm Depth

304 SSS	43752
<b>MB</b>	53752

**320x55mm**  
12mm Depth

304 SSS	43753
<b>MB</b>	53753



**220x55mm**  
10mm Depth

304 SSS	43754E
<b>MB</b>	53754E

Integrated Cylinder Hole  
(Per Pair)



**220x55mm**  
10mm Depth

304 SSS	43754
<b>MB</b>	53754

(Per Pair)



Concealed fixing  
**100x50mm**  
12mm Depth

304 SSS	43739
<b>MB</b>	53739



**120x40mm**  
12mm Depth

304 SSS	43740
<b>MB</b>	53740



Concealed fixing  
**120x40mm**  
12mm Depth

304 SSS	43744
<b>MB</b>	53744

## NARROW (35mm) SLIM LINE FLUSH PULL

Concealed grub screw fixing  
Moulded Solid 304SS without internal edges



**200x35mm**  
14mm Depth

304 SSS	43755
<b>MB</b>	53755

Concealed Grub  
Screw Fixing

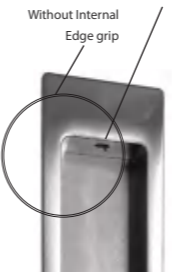

Pictured:  
53755 Black Flush Pull  
53726 Black Square Escutcheon  
59145 Black Cylinder Turn

## DOOR EDGE PULL HANDLE

Ideal for heavier doors, the integrated  
ergonomic handle will assist in retrieving  
the door from its cavity.



**115x25mm**

PB	4456
CP	34456
SC	44456
<b>MB</b>	54456

## DOOR EDGE PULL

Use the edge pull to retrieve the  
door from its cavity.  
Concealed Fixing



**80x23mm**  
40mm Pull

SSS	44455
<b>MB</b>	54455
SB	94455





## Joinery Handles

# Joinery Handles

304 SS

304 STAINLESS STEEL

High Grade 304 Solid Stainless Steel

Minimal 7.8% Nickel content for Strength, Durability and Corrosion resistance

Includes: 2 x 40mm M4 screws with snap off points



L - Overall Length  
C - Screw Fixing Centres  
P - Projection  
D - Diameter

304 SSS

## Handle 1 - Square

	L	C	D	P
48784	115	55	10x20	30
48785	160	100	10x20	30
48786	210	150	10x20	30
48787	260	200	10x20	30
48788	360	300	10x20	30
48789	460	400	10x20	30
48790	560	500	10x20	30
48791	660	600	10x20	30
48792	860	700	10x20	30

304 SSS

## Handle 4 - Round

	L	C	D	P
48750	75	74	10	30
48751	107	98	10	30
48753	170	171	10	30
48754	107	98	12	32
48755	137	126	12	32
48756	170	159	12	32
48757	300	287	12	32
48758	362	351	12	32

304 SSS

## Handle 8 - Square

	L	C	D	P
48800	100	80	6x15	30
48801	130	120	6x15	30
48802	160	140	6x15	30
48803	200	180	6x15	30
48804	300	280	6x15	30
48794	130	110	6x20	30
48795	160	140	6x20	30
48797	300	280	6x20	30
48798	400	380	6x20	30
48799	500	480	6x20	30

304 SSS

## Handle 2 - Square

	L	C	D	P
48708	113	63	12x12	40
48709	146	96	12x12	40
48711	260	210	12x12	40
48712	356	306	12x12	40
48714	452	402	12x12	40
48716	550	500	12x12	40
48717	650	600	12x12	40
48690	113	63	8x8	38
48691	146	96	8x8	38
48692	196	146	8x8	38
48693	260	210	8x8	38
48694	356	306	8x8	38
48695	452	402	8x8	38
48696	550	500	8x8	38

304 SSS

## Handle 5

	L	C	D	P
48771	152	140	8	33
48772	185	173	8	33
48773	240	218	8	33
48774	326	314	8	32

304 SSS

## Handle 9

	L	C	D	P
48776	108	100	10x20	30
48777	158	150	10x20	30
48778	208	200	10x20	30
48779	308	300	10x20	30
48780	408	400	10x20	30
48781	508	500	10x20	30

304 SSS

## Handle 3 - Square

	L	C	D	P
48699	120	108	12x12	30
48700	170	158	12x12	30
48701	212	200	12x12	30
48706	812	800	12x12	30

304 SSS

## Handle 6

	L	C	D	P
48759	106	86	8	35
48761	154	134	8	35
48762	186	166	8	35

304 SSS

## Handle 7

	L	C	D	P
48718	146	96	10	30
48719	196	146	10	30
48720	210	160	10	30
48721	250	200	10	30
48722	300	250	10	30
48723	350	300	10	30
48724	400	350	10	30
48725	450	400	10	30
48728	146	96	12	30
48729	196	146	12	30
48730	210	160	12	30
48731	250	200	12	30
48732	300	250	12	30
48733	350	300	12	30
48736	550	500	12	30
48737	650	600	12	30



SB

## Cabinet Pull Handle

98702  
12 x 12mm x 236mm

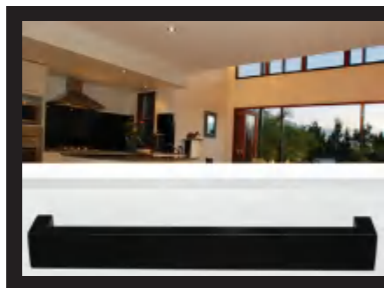

TO ORDER MB

"Ask us about Black Powder Coated Options for most handles in the range"

# Drawer Pull Handles

TO ORDER  
**MB**  
Includes:  
2 x 40mm M4 screws  
with snap off points



<p>96mm - centres 128mm - centres</p> <p><b>PB</b> CP SC 8531 38532 48532</p>	<p>96mm - centres 128mm - centres</p> <p>CP SC 38521 48521 CP SC 38522 48522</p>	<p>96mm - centres 128mm - centres</p> <p>CP SC 38528 48528 CP SC 38529 48529</p>	<p>20x20mm 25x25mm 30x30mm</p> <p><b>PB</b> CP SC 8662 38662 48662 <b>PB</b> CP 8663 38663 <b>PB</b> CP SC 8664 38664 48664</p>	<p>25x25mm</p> <p>CP 38567</p>	<p>40x23mm</p> <p>CP SC 38555 48555</p>	<p>35x28mm</p> <p><b>PB</b> CP SC 8575 38575 48575</p>
<p>96mm - centres 128mm - centres</p> <p>CP SC 38518 48518 SC 48519</p>	<p>96mm - centres 128mm - centres</p> <p>CP SC 38526 48526 CP 48527</p>	<p>96mm - centres 128mm - centres</p> <p>CP SC 38534 48534 CP 48535</p>	<p>25x25mm 30x25mm 35x30mm</p> <p>CP 38677 <b>PVD</b> CP 18678 38678 48678 <b>PVD</b> CP SC 18679 38679 48679</p>	<p>25x25mm 32x32mm 35x33mm</p> <p>CP SC 38659 48659 CP SC 38660 48660</p>	<p>28x27mm 33x27mm</p> <p>CP 38560 CP 38561</p>	<p>8666 20x27mm 8667 25x30mm</p> <p><b>PB</b> CP SC 8666 38666 48666 <b>PB</b> CP SC 38667 48667</p>
<p>96mm - centres</p> <p>CP SC 38523 48523</p>	<p>96mm - centres</p> <p>CP SC 38509 48509</p>	<p>96mm - centres</p> <p>CP SC 38513 48513</p>	<p>25x25mm 30x27mm 35x30mm</p> <p><b>PVD</b> CP SC 18674 38674 48674 <b>PVD</b> CP SC 18675 38675 48675</p>	<p>25x25mm 30x28mm</p> <p><b>PVD</b> CP SC 18671 38671 48671 <b>PVD</b> CP SC 18672 38672 48672</p>	<p>28x20mm 28x26mm</p> <p><b>PB</b> CP SC 8651 38651 48651 <b>PB</b> CP SC 8652 38652 48652</p>	<p>8584 16x20mm Aluminium 8585 20x26mm Aluminium</p> <p>SC 48584 SC 48585</p>
<p>96mm</p> <p>CP 35604</p>	<p>96mm - centres</p> <p>SC 48504</p>	<p>64mm - centres 96mm - centres 128mm - centres</p> <p>CP SC 38505 48505 CP SC 38506 48506 CP SC 38507 48507</p>	<p>25x25mm 30x27mm</p> <p><b>PVD</b> CP SC 18674 38674 48674 <b>PVD</b> CP SC 18675 38675 48675</p>	<p>18x25mm Solid Brass 21x27mm Aluminium</p> <p>SC 48584 CP SC 38585 48585</p>	<p>15x22mm Aluminium 20x26mm Aluminium</p> <p>SC 48580 SC 48581</p>	<p>8651 22x20mm 8652 28x26mm</p> <p><b>PB</b> CP SC 8651 38651 48651 <b>PB</b> CP SC 8652 38652 48652</p>
<p>50x20mm 86x35mm</p> <p>CP SC 38576 48576 CP SC 38577 48577</p>	<p>43x20mm</p> <p>SC 48565</p>	<p>75x18mm</p> <p><b>PB</b> CP SC 3286 33286 43286</p>	<p>18x25mm Solid Brass 21x27mm Aluminium</p> <p>SC 48584 CP SC 38585 48585</p>	<p>15x22mm Aluminium 20x26mm Aluminium</p> <p>SC 48580 SC 48581</p>	<p>32mm</p> <p><b>PB</b> CP SC 8601 38601 48601</p>	<p>35x20mm 47x27mm</p> <p>CP SC 38583 48583 CP SC 38584 48584</p>
<p>75x18mm</p> <p>SC 43293</p>	<p>96mm</p> <p><b>PB</b> CP 5604 35604</p>	<p>96mm</p> <p><b>PB</b> CP 5604 35604</p>	<p>18x25mm Solid Brass 21x27mm Aluminium</p> <p>SC 48584 CP SC 38585 48585</p>	<p>15x22mm Aluminium 20x26mm Aluminium</p> <p>SC 48580 SC 48581</p>	<p>32mm</p> <p><b>PB</b> CP SC 8601 38601 48601</p>	<p>35x20mm 47x27mm</p> <p>CP SC 38583 48583 CP SC 38584 48584</p>

## Concealed Flush Drawer Pull

SSS **MB**  
116mm 48200 58200  
166mm 48201 58201  
190mm 48202 58202  
Thickness: 1.5 mm

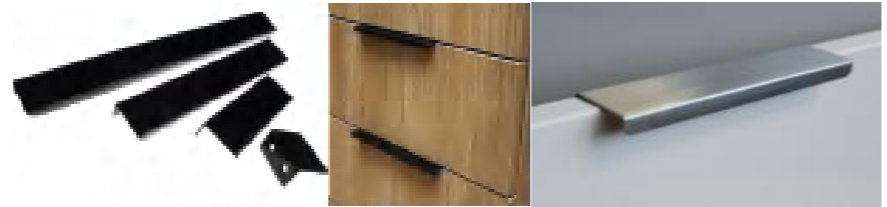

25x30mm  
35x40mm

CP SC  
38557 48557  
CP SC  
38558 48558



# Hinges



# Hinges



Sold in pairs

All hinges include stainless steel/brass phillips head wood screws

M5/12mm metal thread screws available (#9900)

PVD hinges are warranted against tarnishing for 50 years. A highly polished brass finish on a durable stainless steel base provides outstanding strength, long term durability without the worry of corrosion

## Square Knuckle Hinges



Brass Material **SC**  
45120 100x75x2.5mm



Brass Material **PB**  
55120 100x75x2.5mm

## Standard Hinges



Brushed Stainless Steel **316 SSS**  
45316 100x75x2.5mm Fixed Pin  
45317 100x100x2.5mm Fixed Pin  
45318 100x75x2.5mm LoosePin



PVD Polished Brass **PVD**  
15108 100x75x2.5mm Fixed Pin  
15109 100x100x2.5mm Fixed Pin  
15117 100x60x2mm LoosePin  
15118 100x75x2.5mm LoosePin



Antique Copper **ATQ**  
25008 100x75x2.5mm Fixed Pin  
Solid Brass Material - Fire rating not applicable



White **WH**  
85118 100x75x2.5mm LoosePin



Brushed Stainless Steel **304 SSS**  
45105 85x60x2mm Fixed Pin  
45107 100x60x2mm Fixed Pin  
45108 100x75x2.5mm Fixed Pin  
45109 100x100x2.5mm Fixed Pin  
45115 85x60x2mm LoosePin  
45118 100x75x2.5mm LoosePin



Satin Brass **SB**  
95108 100x75x2.5mm Fixed Pin  
95109 100x100x2.5mm Fixed Pin



Matt Black **MB**  
55108 100x75x2.5mm Fixed Pin  
55109 100x100x2.5mm Fixed Pin  
55115 85x60x2mm LoosePin  
55118 100x75x2.5mm LoosePin



Bright Polished Stainless Steel **PSS**  
35108 100x75x2.5mm Fixed Pin  
35109 100x100x2.5mm Fixed Pin  
35115 85x60x2mm LoosePin  
35118 100x75x2.5mm LoosePin

## Heavy Duty Broad Butt Fixed Pin Hinges

Ideally suited for "wider/long" reach or to pass a reveal or extended throw

M5/12mm metal thread screws available (#9900)

PVD hinges are warranted against tarnishing for 50 years.

Sold in pairs



**304 SSS**  
45112 100x125x3mm  
45111 100x150x3mm  
45110 100x175x3mm  
45113 100x200x3mm



**PSS**  
35112 100x125x3mm  
35111 100x150x3mm  
35110 100x175x3mm



**PVD**  
15112 100x125x3mm  
15111 100x150x3mm  
15110 100x175x3mm



**MB**  
55112 100x125x3mm  
55111 100x150x3mm  
55110 100x175x3mm

## Heavy Duty 4 Ball Bearing Hinges



Sold as Singles

304 SS BALL BEARING



45508 100x75x2.5mm **304 SSS**



35508 100x75x2.5mm **PSS**



55508 100x75x2.5mm **MB**



45509 100x100x2.5mm **304 SSS**



35509 100x100x2.5mm **PSS**



55509 100x100x2.5mm **MB**



## Fast Fix Hirline Flush Hinges

No rebating required

Ideal for timber or aluminium applications

M5/12mm metal thread screws available (#9900)

Heavy duty stainless steel ball bearings

PVD hinges are warranted against tarnishing for 50 years.

Sold in Pairs

304 SS BALL BEARING RACE MECHANISM

316 SS

316 STAINLESS STEEL



316 SSS  
45344 100x47x2.5mm



304 SSS  
45144 100x47x2.5mm



PSS  
35144 100x47x2.5mm



PVD  
15144 100x47x2.5mm



MB  
55144 100x47x2.5mm



304 SSS  
45143 89x35x2mm



Small Size Non-Bearing  
304 SSS  
45142 76x30x1.5mm



## Fast Fix Hirline Aluminium Hinges

No rebating required

Ideal for timber or aluminium applications

M5/12mm metal thread screws available (#9900)

Heavy duty stainless steel ball bearings

Sold as Singles



45444 100x48x3.2mm 304 SSS



55444 100x48x3.2mm MB



## Long Body Hinges

Heavy Duty 4 Ball Bearing Butt Hinge

Extended 150mm body and 3mm thickness for additional strength.

Door Weight Recommendations: 2pcs/40kgs 3pcs/60kg

Sold as Singles



45514 150x88x3mm 304 SSS



55514 150x88x3mm MB



## Radius Hinges

Radius corners for simple & easy installation using a router.

Heavy Duty 2 Ball Bearing Hinges

Door Weight Recommendations: 2pcs/40kgs 3pcs/60kg

Sold in Pairs



304 SSS  
45408 100x75x2.5mm  
45409 100x100x2.5mm



MB  
55408 100x75x2.5mm  
55409 100x100x2.5mm

## Universal Lift Off Hinge - All Toilet / Bathroom Doors

Used for all residential or commercial toilet/bathroom door applications

Used for either LEFT or Right handed opening doors

"Frame" and "Door" marked on the hinge to make installation simple and easy

12mm Pin for easy removal of the door

Sold as Singles



45239 100x75x2.5mm 304 SSS



35239 100x75x2.5mm PSS



15239 100x75x2.5mm PVD



55239 100x75x2.5mm MB

## Lift Off Hinge

Required for all domestic/commercial bathroom door installations

12mm pin length (lift off distance) for quick and easy lifting

M5/12mm metal thread screws available (#9900)

PVD hinges are warranted against tarnishing for 50 years.

Sold in Pairs

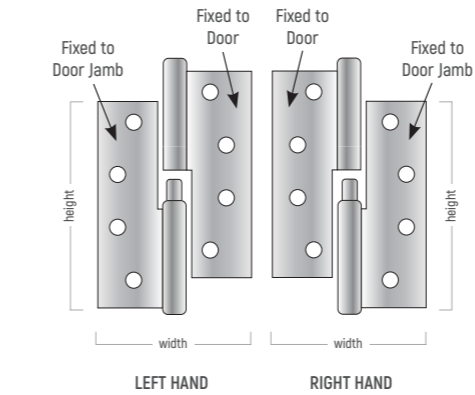

## Self Closing Rising Hinge

Suits all domestic/commercial bathroom installations

M5/12mm metal thread screws available (#9900)

Sold in Pairs

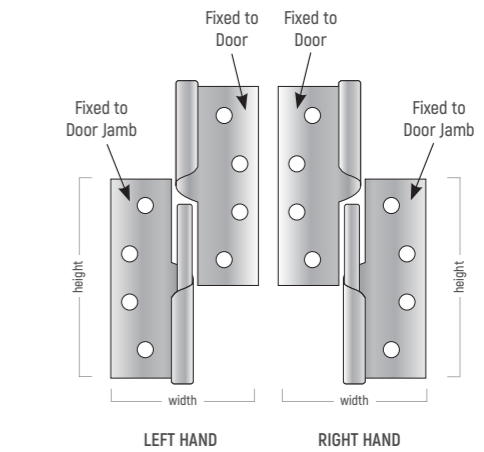

304 SSS  
45130 89x60x2.5mm Left Hand  
45131 89x60x2.5mm Right Hand



PVD  
15130 89x60x2.5mm Left Hand  
15131 89x60x2.5mm Right Hand



304 SSS  
45134 100x75x2.5mm Left Hand  
45135 100x75x2.5mm Right Hand







## Door & Window Bolts Flush Bolts Panic Bolts

# Flush, Panic, Door Window Bolts

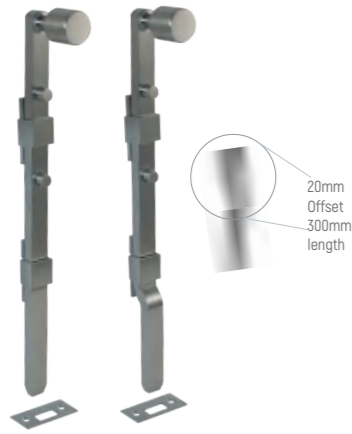

## Panic Bolt - Heavy Duty

Reinforced solid saddle for additional strength  
Solid brass and heavy duty fixings  
Concealed fixing

	225mm	300mm	300mm Offset	450mm	600mm
<b>PB</b>	5025	5026	5046	5027	5028
<b>CP</b>	35025	35026	35046	35027	35028
<b>SC</b>	45025	45026	45046	45027	45028

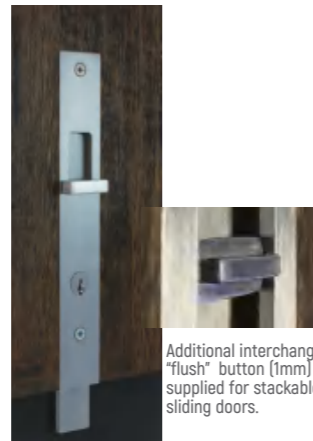

## Lockable High Security Flush Bolt

200x30mm

<b>PB</b>	5195
<b>SC</b>	45195

15mm Flush Bolt Depth  
22mm Cylinder Recess depth

Supplied with interchangeable buttons for both hinged doors or stackable sliding doors

C4 Cylinder profile can be re-keyed to match existing cylinders

Heavy Duty Solid Brass material



Both bolts include multiple housing options

## Spring Loaded Window or Door Bolt

<b>CP</b>	39112	40x42mm
<b>CP</b>	39111	135x42mm

Concealed design & upgraded spring mechanism

C4 cylinder key

Spring loaded bolt release

31mm Projection



## Spring Loaded Barrel Bolt - Heavy Duty

20mm bolt throw

<b>SC</b>	49121	85x42mm
-----------	-------	---------

Push Button Release

## Accessories



### Angle & Floor Keepers

For flush /barrel bolts

<b>PB</b>	<b>CP</b>	<b>SC</b>	<b>MB</b>
4305	34305	44305	54305



### Flat Keeper

For panic bolts

<b>PB</b>	<b>CP</b>	<b>SC</b>	<b>MB</b>
9854	39854	49854	59854



### Spring

For panic bolts

<b>PB</b>
9856

### 9855 - Saddles

For panic bolts

<b>PB</b>	<b>CP</b>	<b>SC</b>	<b>MB</b>
9855	39855	49855	59855



### Flat Keeper

Specify particular bolt

<b>PB</b>	<b>ATQ</b>	<b>CP</b>	<b>SC</b>	<b>MB</b>
9850	29850	39850	49850	59850



### Cylindrical Ferrule Keepers

10x10mm diameter

<b>CP</b>
39849



### Barrel Bolt Raised Keeper

Specify particular bolt

<b>PB</b>	<b>ATQ</b>	<b>CP</b>	<b>SC</b>	<b>MB</b>
9854	29854	39854	49854	59854

# Flush Bolts



## Streamline Flush Mount Reverse Barrel Bolt

### Wide Mount - 45mm bolt throw

100x32mm	<b>PB</b>	<b>ATQ</b>	<b>CP</b>	<b>SC</b>	<b>MB</b>
	5178	25178	35178	45178	55178

150x32mm	<b>PB</b>	<b>ATQ</b>	<b>CP</b>	<b>SC</b>	<b>MB</b>
	5179	25179	35179	45179	55179

### Slim Mount - 34mm bolt throw

75x19mm	<b>PB</b>	<b>CP</b>	<b>SC</b>	<b>MB</b>
	5181	35181	45181	55181

150x19mm	<b>PB</b>	<b>CP</b>	<b>SC</b>	<b>MB</b>
	5180	35180	45180	55180

Concealed Reverse Barrel

12mm straight route rebate for easy installation

Bolt is neatly boxed at rear

Smooth Slide button operation



## Easy Fix - Heavy Duty Flush Bolt

25mm bolt throw

150x19mm	<b>PB</b>	<b>ATQ</b>	<b>CP</b>	<b>SC</b>	<b>MB</b>
	5182	25182	35182	45182	55182

200x19mm	<b>PB</b>	<b>ATQ</b>	<b>CP</b>	<b>SC</b>
	5183	25183	35183	45183

450x22mm	<b>PB</b>	<b>CP</b>	<b>SC</b>
	5185	35185	45185

Reinforced guide behind bolt for additional strength

Minimal rebate for installation

Push button operation



## Heavy Duty Barrel Bolt

25mm bolt throw

75x32mm	<b>PB</b>	<b>ATQ</b>	<b>CP</b>	<b>SC</b>	<b>MB</b>
	4267	24267	34267	44267	54267

100x32mm	<b>PB</b>	<b>ATQ</b>	<b>CP</b>	<b>SC</b>	<b>MB</b>
	4268	24268	34268	44268	54268

150x32mm	<b>PB</b>	<b>ATQ</b>	<b>CP</b>	<b>SC</b>	<b>MB</b>
	4269	24269	34269	44269	54269

### 50mm extended bolt throw

100x32mm	<b>PB</b>	<b>ATQ</b>	<b>CP</b>	<b>SC</b>	<b>MB</b>
	4263	24263	34263	44263	54263

150x32mm	<b>PB</b>	<b>ATQ</b>	<b>CP</b>	<b>SC</b>	<b>MB</b>
	4264	24264	34264	44264	54264

200x32mm	<b>PB</b>	<b>ATQ</b>	<b>CP</b>	<b>SC</b>	<b>MB</b>
	4265	24265	34265	44265	54265



## Standard All Purpose Flush Bolt

25mm bolt throw

150x19mm	<b>PB</b>	<b>CP</b>	<b>SC</b>
	5030	35030	45030

200x19mm	<b>PB</b>	<b>CP</b>	<b>SC</b>
	5031	35031	45031

Mini: 105x19mm	<b>PB</b>
	5029

Reinforced guide behind the face for additional strength



## Heavy Duty Barrel Bolt - Offset Bolt

20mm bolt throw

100x32mm	<b>PB</b>	<b>ATQ</b>	<b>CP</b>	<b>SC</b>	<b>MB</b>
	4271	24271	34271	44271	54271

150x32mm	<b>PB</b>	<b>ATQ</b>	<b>CP</b>	<b>SC</b>	<b>MB</b>
	4272	24272	34272	44272	54272



## Concealed Fixing Heavy Duty Flush Bolt

34mm bolt throw

150x19mm	<b>PB</b>	<b>ATQ</b>	<b>CP</b>	<b>SC</b>
	4444	24444	34444	44444

200x19mm	<b>PB</b>	<b>ATQ</b>	<b>CP</b>	<b>SC</b>
	4445	NA	34445	44445

Reinforced solid saddle for additional strength



## Door Stops Door Catches

# Door Stops

304  
SS

304  
STAINLESS STEEL

Includes expansion bolt & wood screw fixing options

- Black items are plated to order

Wall Mount Floor Mount

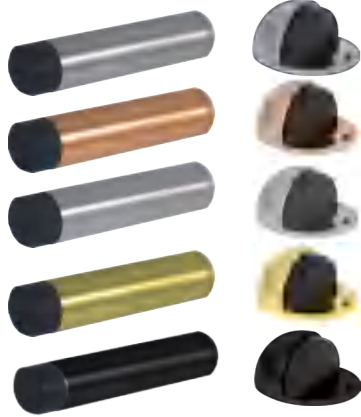

WH

All Matt White Door Stops Are Plated To Order

## Hands Free Foot Operated Door Pull

100x75x30mm  
Counter sunk screws for a professional finish  
Includes rubber stop for additional protection.

304  
SSS MB  
43719 53719



Wall Mounted

Round Tube  
Length: 75mm / Diameter: 17mm

PB PSS 304 MB COP WH SB  
13717 33717 43717 53717 63717 83717 93717



Wall Mounted

Square  
Length: 85mm / Diameter: 22x22mm

PVD CP SC MB  
3711 33711 43711 53711



Floor Mounted  
Flat Top

Height: 40mm / Dia: 30mm / Rubber 34mm

PSS 304 SSS MB\*  
33714 43714 53714



Floor Mounted  
Round Top

Height: 50mm / Dia: 30mm / Rubber 40mm

PSS 304 SSS MB\*  
33713 43713 53713



Floor Mounted  
Square

Height: 45mm / 22x22mm

PB PSS 304 SSS MB\*  
3710 33710 43710 53710



Floor Mounted  
Heavy Rubber 40mm

Height: 40mm / Diam. 30mm

PB PSS 304 SSS MB\*  
13715 33715 43715 53715



Floor Mounted  
Half Moon Riser/Extended Base -12mm

Diameter: 45mm

PB PSS 304 SSS MB\*  
4302 34302 44302 54302



Floor Mounted  
Half Moon

Diameter: 45mm

PB ATQ PSS 304 SSS MB COP  
3080 23080 33080 43080 53080 63080  
WH SB  
83080 93080

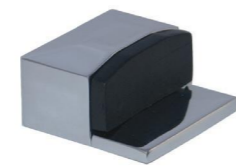

Floor Mounted  
Square

Length: 40mm

SC MB  
43718 53718



Floor Mounted  
Triangle

Diameter: 45mm

CP MB  
33728 53728

# Door Catch & Holding Mechanisms



Door/Skirt Mounted Door Catch  
Heavy Duty  
Catch: 55mm - projection  
Base: 65mm - projection

PB CP SC  
3320 33320 43320



Door/Skirt & Floor Mounted Door Catch  
Floor Mount Heavy Duty  
Catch: 32mm - projection  
Base: 25x25mm

PB CP SC  
3321 33321 43321



Door/Skirt Mounted Door Catch  
Heavy Duty  
Catch: 38mm - projection  
Base: 65mm - projection

PB CP SC MB  
3322 33322 43322 53322



Magnetic Catch  
Length: 45mm  
Width: 34mm

SC  
43727



Magnetic Catch  
Length: 53mm  
Width: 34mm

PB CP SC  
3722 33722 43722



Magnetic Catch  
Raised base for elevated catching height  
Length: 45mm Width: 38mm

PB CP SC  
3723 33723 43723



Magnetic Catch  
Square Design - Floor or Wall Mounted  
Height: 75mm  
Base: 48x48mm

CP SC MB  
33729 43729 53729



Foot Operated Door Catch  
Door Mounted  
Height/Width: 145x27mm  
Throw: 55mm

CP SC  
34099 44099



Door Closer with Adjustable Closing Tension  
Spring loaded - Modern concealed fix  
Height/Width: 115x30mm  
Recommended for internal doors

SC  
43730

# Numerals Alphabet Signage



# Numbers and Alphabet



0123456789

FONT: Arial Numbers 0-9  
 4891+[#0-9] 130mm SSS  
 4892+[#0-9] 150mm SSS  
 4893+[#0-9] 225mm SSS

0123456789

FONT: Arial Numbers 0-9  
 3891+[#0-9] 130mm PSS  
 3892+[#0-9] 150mm PSS

0123456789

FONT: Arial Numbers 0-9  
 5891+[#0-9] 130mm MB  
 5892+[#0-9] 150mm MB  
 5893+[#0-9] 225mm MB

ABCDEFGHIJKLM  
 NOPQRSTUVWXYZ

FONT: Arial Letters A-Z  
 48104+[A-Z] 150mm SSS

ABCDEFGHIJKLM  
 NOPQRSTUVWXYZ

FONT: Arial Letters A-Z  
 58104+[A-Z] 150mm MB

abcd abcd abcd

FONT: Arial Letters - 55mm

48100 = a SSS 48101 = b SSS  
 48102 = c SSS 48103 = d SSS

FONT: Arial Letters - 55mm

38100 = a PSS 38101 = b PSS  
 38102 = c PSS 38103 = d PSS

FONT: Arial Letters - 55mm

58100 = a MB 58101 = b MB  
 58102 = c MB 58103 = d MB

# Bathroom Door Signage



Acrylic black bathroom signage.

150mm Height  
 Male | Female | Disable  
 Includes aligning template. (glue no included)  
**MB** 58130 1 Set includes three figures

B&C

FONT: Times New Roman Alphabet A-Z

3064+[A-Z] 75mm PB  
 3065+[A-Z] 150mm PB

B&C

FONT: Times New Roman Alphabet A-Z

33064+[A-Z] 75mm CP  
 33065+[A-Z] 150mm CP

123

Numbers 0-9

1881+[#0-9] 25mm PVD  
 1882+[#0-9] 50mm PVD  
 1883+[#0-9] 75mm PVD  
 1884+[#0-9] 100mm PVD  
 1885+[#0-9] 150mm PVD

123

Numbers 0-9

3882+[#0-9] 50mm PSS  
 3883+[#0-9] 75mm PSS  
 3884+[#0-9] 100mm PSS  
 3885+[#0-9] 150mm PSS

821

Numbers 0-9

1887+[#0-9] 75mm PVD  
 1888+[#0-9] 100mm PVD

821

Numbers 0-9

3887+[#0-9] 75mm PSS  
 3888+[#0-9] 100mm PSS





Opening Doors in auSTYLE



P +61 3 9553 3559

E [info@austyle.com.au](mailto:info@austyle.com.au)

 [superioraustyle](https://www.instagram.com/superioraustyle)

 [austyle architectural hardware](https://www.facebook.com/austylearchitecturalhardware)

[www.austyle.com.au](http://www.austyle.com.au)

Service Supply & Support Since 1982



Quality is never an accident; it's the result of intention, innovation & skillful execution.